

## CM907 PROGRAMMABLE THERMOSTAT

### PRODUCT SPECIFICATION SHEET



The **CM907** thermostat is designed to provide automatic time and temperature control of heating or cooling systems in villas and apartments.



It can be used as part of a system in conjunction with combi-boilers, oil-burners and gas fired boilers, circulation pumps, thermal actuators, zone valves and electric heat systems (<8A).

The **CM907** is designed with the installer in mind and includes a moulded back-plate with trunking guides and wiring breakouts to make installation quick and easy.

The **CM907** extra large LCD display, dynamic text display, button layout based on the same simple programming philosophy used on our acclaimed CM60 products and the introduction of an 'OK' button, makes it easier to install and more user friendly.

The unit is ideal for consumers who want reliable precise temperature control from a modern looking, simple to program and easy to use product.

## FEATURES

- Attractive, slim, ultra-modern styling makes it ideal for location in any type of home.
- 7-day heating program.
- A dynamic text display on the LCD that gives enhanced feedback to the user / installer.
- Up to 6 daily independent time and temperature level changes let you set 6 time and temperatures pairs to suit your lifestyle.
- LCD Backlighting to illuminate the display for easier viewing in low light conditions.
- Temporary programmed temperature override to override the programmed temperature till the next switch point.
-  Party feature that temporarily maintains a selectable constant temperature for 1-23 hours, then returns to normal operation.
-  Day Off feature that follows Sunday's program for 1 to 99 days, allowing selection of a different heating program without having to re-program the thermostat.
-  Holiday button that provides energy savings by reducing to a constant temperature from 1 to 99 days when people are on holiday, returning to normal operation (AUTO or MANUAL) on the day of their return.
- Room Temperature Enquiry.
- EEPROM memory holds the user program indefinitely.
- OFF position has an integral frost protection setting at minimum 5°C (installer adjustable) so that pipes in the house will never freeze in winter.
- 24...230V 8A resistive, 3A inductive SPDT relay provides compatibility with most domestic central heating systems reducing the need to stock many different models.
- Battery powered by 2 x AA size (LR6) alkaline cells.
- Minimum battery life of 2 years with low battery warning indicator.
- Built-in default heating program.
- Automatic Summer / Winter time change adjusts the time automatically to daylight saving time.
- Telephone interface can be fitted to allow remote switching between program modes and a fixed set-point.
- Surface or wall-box mounting options with trunking guides and wiring breakouts to simplify installation.
- No installer links or special installer switches on the back of the unit mean no adjustment is required for combi-boilers and most domestic central heating systems.
- User Set-Up Mode allows extra functions to be set at the discretion of the user:
  - AM-PM or 24hr time display.
  - Resetting the heating profile to factory default.
  - Enable / disable of Auto Summer / Winter time change.
  - Languages selection of the user interface (on selected models only).
- Installer Set-Up Mode allows extra functions to be set at the discretion of the installer to match the consumers applications and needs:
  - Optimisation.
  - Pump Exercise.
  - Upper / Lower Set point Limit Adjust.
  - Temperature offset.
  - Minimum ON time.
  - Cycle rate.
  - Heat / Cool operation.
  - Proportional Band Width.
- Diagnostic Mode to assist in faultfinding.

## CONTROLS/DISPLAY LAYOUT

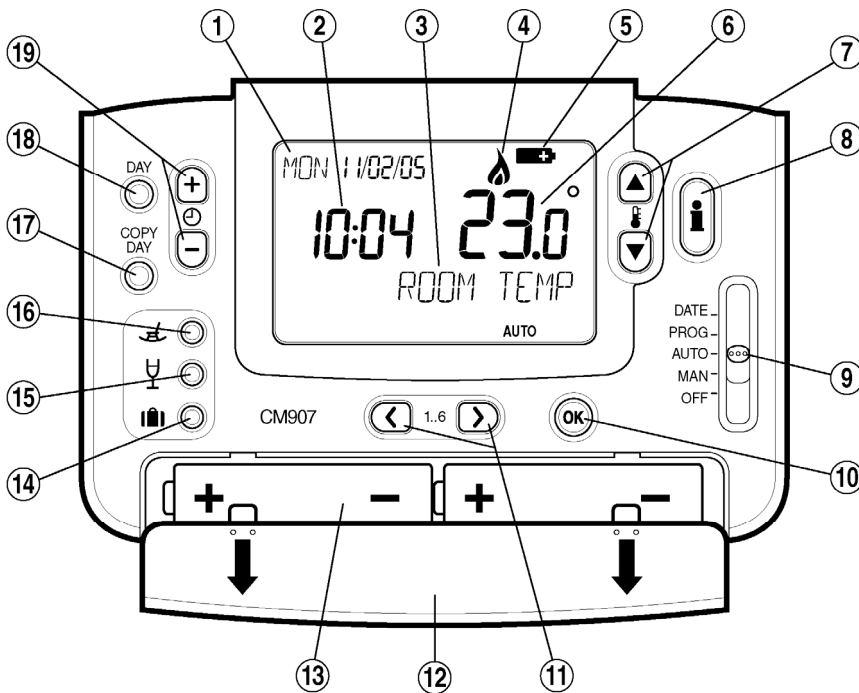

### PRODUCT LAYOUT:

1. Day & Date Display
2. Time Display
3. Dynamic Text Display (DTD)
4. Burner On Indicator
5. Battery Low Indicator
6. Temperature Display
7. Temperature Change Buttons
8. Information Enquiry Button
9. Slider Switch
10. Green OK Button
11. Program Buttons
12. Battery Cover
13. Battery Compartment
14. Holiday Button
15. Party Button
16. Day Off Button
17. Copy Day Button
18. Day Select Button
19. Time Change Buttons

## SPECIFICATIONS

Batteries	: 2 x 1.5 V IEC LR6 (AA) Alkaline cells
Battery life	: Minimum 2 years
Battery replacement	: Program retained in EEPROM
Switch type	: SPDT (potential free)
Electrical rating	: 230 V~, 50...60 Hz, 0.5 A to 8 A resistive 0.5 A to 3 A inductive (0.6 pf) 24 V~, 50...60 Hz, 0.5 A to 8 A resistive 0.5 A to 3 A inductive (0.6 pf)
Time display	: 24 hour or 12 hour AM/PM format
Time keeping accuracy	: Typically better than 10 minutes per year
Program	: 7-day with 6 daily time and temperature level changes
Time setting resolution	: Time of day - 1 minute Program - 10 minute steps
Sensing element	: 100K (@ 25°C) NTC thermistor
Temperature setting range	: Program : 5 to 35°C in 0.5 °C steps Frost : 5°C or equal to lower limit (5°C to 21°C). Frost protection does not work in cooling mode.

Temperature control accuracy	: ±0.5 K (nominal) @ 20°C, 50% load 3 K Δ/hour
Room Temperature display range	: From 0°C to 50°C
Control form	: P + I (Proportional + Integral)
Minimum ON time	: 10% of cycle time (min one minute), adjustable to 2 to 5 min (see installer set up)
Cycle rate	: Selectable by application (see installer set up)
Wiring	: Terminal block capable of accepting wires up to 2.5 mm <sup>2</sup>
Wire access	: Mains wiring – rear right. Low voltage wiring – rear right.
Dimensions	: 133 x 89 x 26 mm (w x h x d) 133 x 175 x 26 mm (w x h x d) (flap open)
Environmental	: Operating temperature range 0 to 40°C Shipping and storage temperature range -20 to 55°C Humidity range 10 to 90% rh, non-condensing
Approvals	: Designed to meet European EN approvals EN60730-1(Nov 2000), EN55014-1 (1997), EN55014-2 (2000)

## INSTALLER SET-UP

To enter the installer set-up mode:

- Move the slider switch to the **OFF** position.
- Press and hold the **INFO i** button and the two program buttons '<' >' together.
- The unit will display the first parameter of installer parameter group category 1 (from n.1 to n.19).
- Press the **TEMP ▲** or **▼** buttons to change the factory setting. The display will flash indicating that a change has been made.
- Press the green **OK** button to confirm this change and the display will stop flashing.
- Press the **⌚ +** button to go to the next parameter.
- Press the program button **>** to go to category 2 in the Installer mode (from n.1 to n.5).
- To exit the installer mode, move the slider switch to the **AUTO** or **MAN** positions.

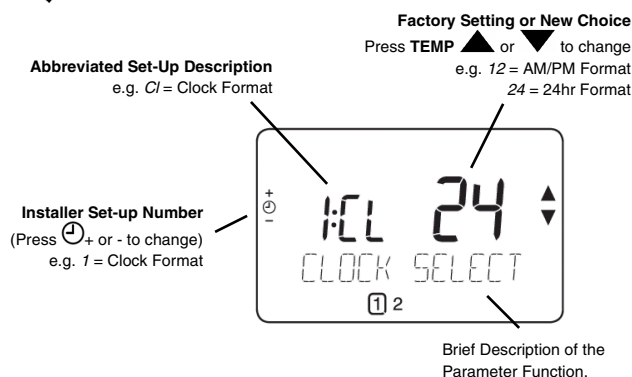
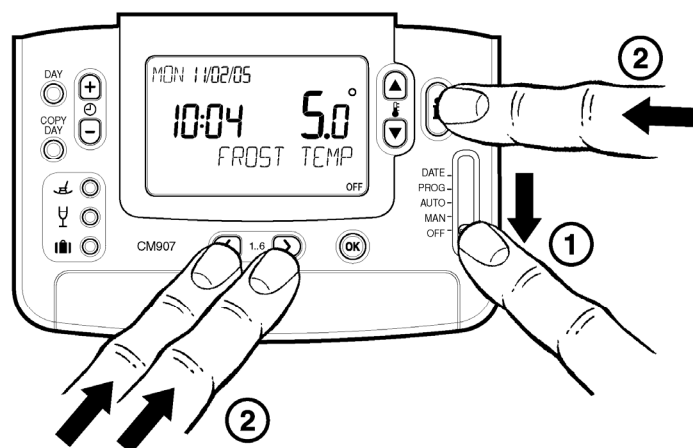

### In Installer set-up we can:

- Set-up specific applications
- Enable special features
- Establish support for optional accessories

Specific Applications		Setting		What do you need to change?
		Cycle/ Hour	Minimum ON time (in minutes)	<b>Note :</b> a. To change Cycle/Hour, please go to parameter n. 2, category 2 in the installer set-up mode. b. To change Minimum ON Time, please go to parameter n. 1, category 2 in the installer set-up mode.
Heating	Gas Boilers (<30KW)	6	1	No action required
	Oil Boiler	3	4	1. Set Minimum ON Time to 4 minutes. 2. Set Cycle/Hour to 3.
	Thermal Actuator	12	1	Set Cycle/Hour to 12.
	Zone valve	6	1	No action required.
	Electric heating (for applications <8A)	12	1	1. Configure the thermostat for electric heating (set parameter n.3, category 2 in the installer set up mode to 1). 2. Set Cycle/Hour to 12.
Air conditioning				1. Configure the thermostat to allow switching between heating and cooling modes (set parameter n.4, category 2 in the installer set-up mode to 1) 2. Set the thermostat accordingly to the required mode of operation (heating or cooling) by pressing the <b>TEMP ▲</b> or <b>▼</b> buttons together for 5 seconds. Modify the cooling program as required.
	Heat Pump/ Air conditioner	3	4	1. Set Minimum ON Time to 4 minutes. 2. Set Cycle/Hour to 3.
	Fan coil	6	1	No action required.

Special Features	Description	What to do if we wish this feature
Optimisation (Variable Start Time) <i>Adaptive Intelligence recovery TM</i>	The thermostat will adjust the start time in the morning/afternoon so the desired temperature is reached by the start of the program period e.g. Time 7:00, Temp 21 °C. The thermostat will monitor the accuracy of the start up and use this information to modify the calculation for the following day by changing the ramp rate (initial 3 K/hr) .The system will restrict the start time to a max of 2 hours. <i>Note:</i> Optimisation will not work in cooling mode.	Set parameter n.8, category 1 in the installer set-up mode to 1.
AM-PM/ 24hr Display	Change display format (default 24hr).	Set parameter n.1, category 1 in the installer set -up mode to 12.
Pump exercise	When enabled the Pump Exercise will switch the relay on for 1 minute at 12:00 if the relay has not been switched on since 12:00 the previous day. While in Holiday mode the Pump Exercise feature, if enabled, will operate.	Set parameter n.5, category 2 in the installer set -up mode to 1.
Upper Temperature Limit	The normal upper temperature limit of 35°C can be reduced down to 21°C to save the homeowner energy. Useful if the homeowner rents to tenants.	Set parameter n.6, category 1 in the installer set -up mode to the desired limit.
Lower Temperature Limit	The normal lower temperature limit of 5°C can be increased up to 21°C to protect the inhabitants from cold. Useful if the inhabitants include the elderly, children or disabled.	Set parameter n.7, category 1 in the installer set -up mode to the desired limit.
Temperature Offset	If the thermostat is located in a hot/cold location and cannot be moved because of wiring then the measured/ displayed temperature can be adjusted by +/- 3°C. Useful if the homeowner wants the reading to match another appliance temperature display.	Set parameter n.12, category 1 in the installer set -up mode to the desired offset value.
Proportional Band Width	Can be adjusted up to 3°C (default is 1.5°C) to provide better temperature control (less overshoot). Useful for: a. Well insulated homes with over-sized heating systems. b. Air systems with fast response.	Set parameter n.13, category 1 in the installer set -up mode to the desired value.

Optional Accessories	Description	What to do if we wish this feature
Outside Temperature Sensor (F42010971 001)	An Outside Temperature Sensor can be fitted, allowing the homeowner to display the outside temperature on the thermostat display by pressing the INFO  button. The thermostat will read the outside temperature every 10 minutes. Outside temperature display range is from -30°C to +45°C. The sensor can be connected up to 50 meters from the unit.	<ol style="list-style-type: none"> <li>Fit the sensor (instructions included in the sensor package).</li> <li>Set parameter n. 10, category 1 in the installer set-up mode to 1.</li> </ol>
Remote Temperature Sensor (F42010972 001)	A Remote Temperature Sensor can be fitted, allowing the thermostat to control the temperature from another room or space, where it is inconvenient to locate the thermostat. It will read the remote sensor every 1 minute. The sensor can be connected up to 50 meters from the unit. Useful for commercial premises where the public may tamper with the product.	<ol style="list-style-type: none"> <li>Fit the sensor (instructions included in the sensor package).</li> <li>Set parameter n. 10, category 1 in the installer set-up mode to 2.</li> </ol>

Parameter	Installer Set-Up Number / Abbreviation (Press + or - keys to select)	Factory Setting		Optional Setting		Installer Set-Up Category (Press PROG keys '<' or '>' to select)
		Display	Description	Display/Setting	Description	
<b>Category 1: Thermostat Parameters</b>						
AM-PM / 24hr Display	1:Cl	24	24 hr clock display	12	12 hr AM / PM clock display	1
RESET Time / Temperature Program	2:rP	1	Time / Temperature profile set to factory default Changes to 0 when one of the time/temp profiles are changed	0 1	Time / Temperature are as programmed To restore the factory profile set to 1	1
Automatic Summer/Winter Time Chqng	3:tC	1	Automatic Summer/Winter Time Change Enabled	0	Automatic Summer/Winter Time Change Disabled	1
Backlight Display	5:bL	1	Backlight Display Enabled	0	Backlight Display Disabled	1
Upper Temperature Limit	6:uL	35	35°C Upper Temp. Limit	21 to 34	21°C to 34°C adjustment in 1°C steps	1
Lower Temperature Limit	7:LL	5	5°C Lower Temp. Limit	6 to 21	6°C to 21°C adjustment in 1°C steps	1
Optimisation	8:0P	0	Optimisation disabled	1	Optimisation enabled	1
Remote Control Setpoint (e.g. via telephone module)	9:tS	0	Disabled	1	Enabled	1
Second Temperature Sensor	10:SS	0	No sensor fitted	1, 2	1 - Outside Temperature Sensor fitted 2 - Remote Temp. Sensor fitted	1
Temperature Offset	12:tO	0	No offset	-3 to +3	-3°C to +3°C adjustment in 0.1°C steps	1
Proportional Band Width	13:Pb	1.5	1.5°C Proportional Band	1.6 to 3.0	1.6°C to 3.0°C adjustment in 0.1°C steps	1
Reset Parameters to Factory Defaults	19:FS	1	All settings held are the factory defaults. Changes to 0 when one of the parameter values are changed	0 1	Settings are as modified above To restore the factory profile set to 1	1
<b>'Category 2: System Parameters (You must press the '&gt;' program key to enter this section)</b>						
Minimum boiler ON Time	1:Ot	1	1 minute minimum ON time	2 to 5	2 - 2 minutes 3 - 3 minutes 4 - 4 minutes 5 - 5 minutes	2
Cycle Rate	2:Cr	6	6 cycles per hour (cph) for gas boilers, zone valves and fan-coil	3, 9, 12	3 - 3 cph 9 - 9cph 12 - 12 cph	2
Electric Heat	3:Eh	0	Applications < 3A	1	Applications 3 - 5A	2
Heat / Cool Change	4:HC	0	Disabled	1	Enabled	2

## DIMENSIONS

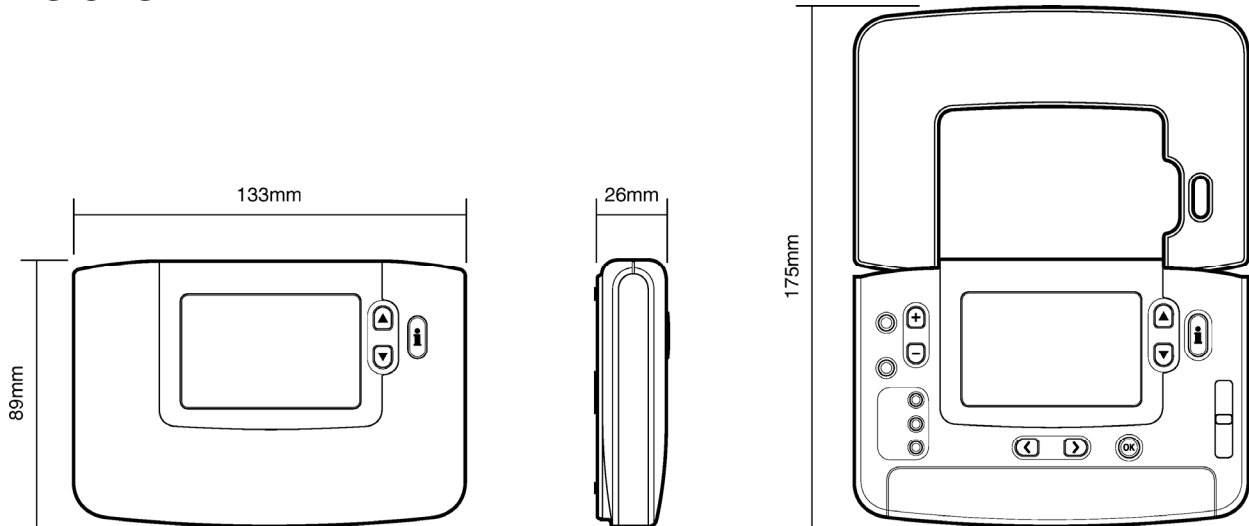

## INSTALLATION

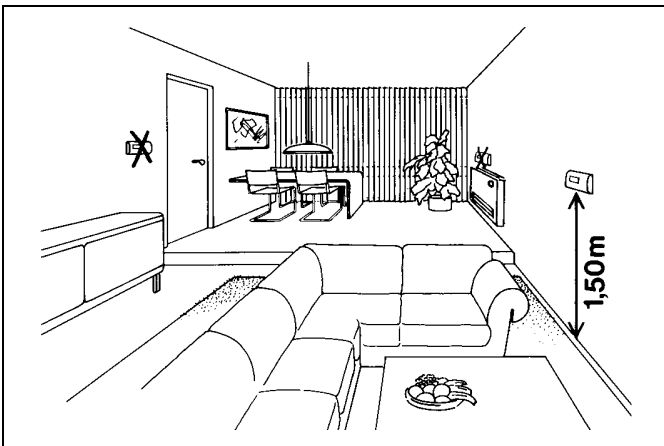

### LOCATION

The **CM907** thermostat is the control element of the heating / cooling system and, therefore, **MUST** be located in a position with good air circulation, at average room temperature and on an inside wall 1.5 metres, above the floor level. Do not position the **CM907** thermostat near sources of heat (radiators, hot air vents, TV or lights), near doors or windows, or in direct sunlight.

### MOUNTING

The **CM907** thermostat can be mounted directly on the wall surface or on an electrical wallbox.

### WIRING

The **CM907** thermostat is designed for fixed wiring only and must be installed in accordance with the latest I.E.E. regulations. Ensure the wiring connection to the supply is via a fuse rated at no more than **8 amps** and a Class "A" switch (having contact separation of at least 3 mm in all poles).

### IMPORTANT

1. *The installer must be a trained service engineer*
2. *Disconnect the power supply before beginning installation*

# WIRING

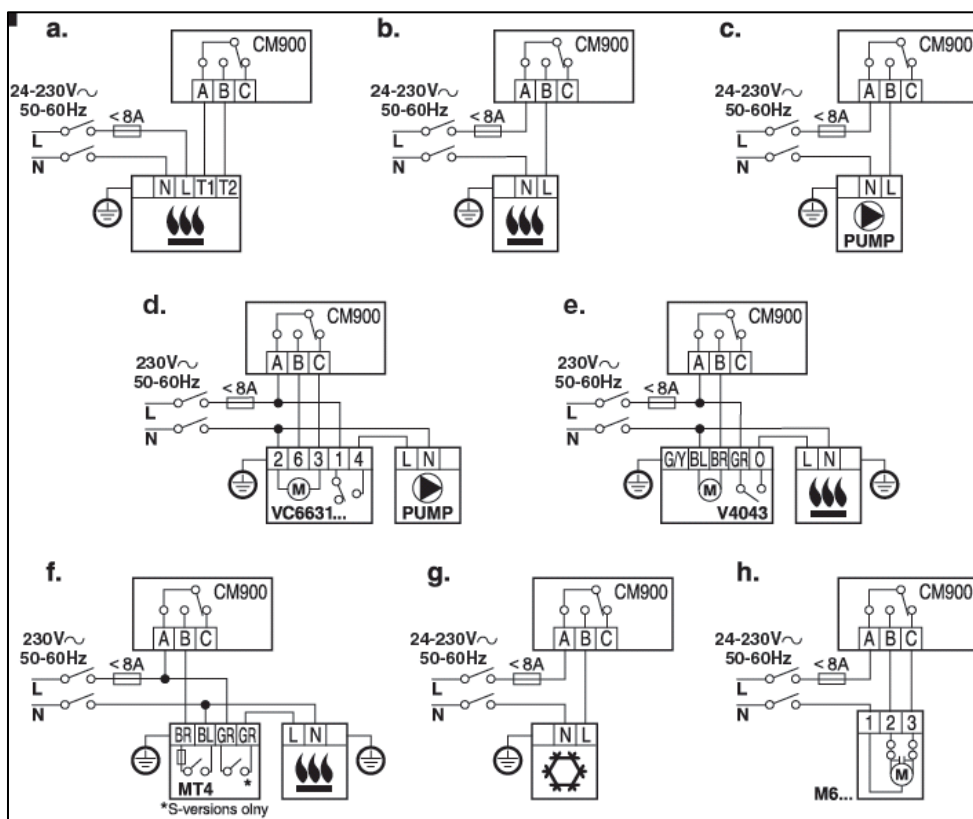

# ORDERING SPECIFICATION

Description	Model	Logo	Literature	Availability	Spec Sheet
7-day programmable thermostat	<b>CMT907A1041</b>	Honeywell	English (UK).	<b>Dec 05</b>	<b>ENOH8547</b>
7-day programmable thermostat	<b>CMT907A1025</b>	Honeywell	French.	<b>Dec 05</b>	<b>ENOH8547</b>
7-day programmable thermostat	<b>CMT907A1017</b>	Honeywell	French & Dutch.	<b>Jan 06</b>	<b>ENOH8547</b>
7-day programmable thermostat	<b>CM907i</b>	Honeywell	Italian.	<b>Jan 06</b>	<b>ENOH8547</b>
7-day programmable thermostat	<b>CMT907A1033</b>	Honeywell	Spanish.	<b>Jan 06</b>	<b>ENOH8547</b>
7-day programmable thermostat	<b>CMT907A1066</b>	Honeywell	Hungarian	<b>Mar 06</b>	<b>ENOH8547</b>
7-day programmable thermostat	<b>CMT907A1074</b>	Honeywell	German / Portuguese Czech / Slovakian / Polish	<b>Oct 06</b> <b>Oct 06</b>	<b>ENOH8547</b>

Description	Model	Logo	Literature	Availability	Spec Sheet
CM900 Remote Temp Sensor	<b>F42010972 001</b>	Honeywell	Multi-lingual	<b>Sep 06</b>	<b>ENOH8554</b>
CM900 Outdoor Temp Sensor	<b>F42010971 001</b>	N/A	Multi-lingual	<b>Sep 06</b>	<b>ENOH8553</b>
CM900 Telephone Interface Terminal Block	<b>F42010977 001</b>	N/A	Multi-lingual	<b>Sep 06</b>	<b>N/A</b>



Honeywell Control Systems Limited  
 Newhouse Industrial Estate  
 Motherwell ML1 5SB  
 United Kingdom

<http://europe.hbc.honeywell.com>