

V2467 Verafix-EK-MES

LOCKSHIELD VALVE-SETS FOR COMPACT RADIATORS

PRODUCT DATA

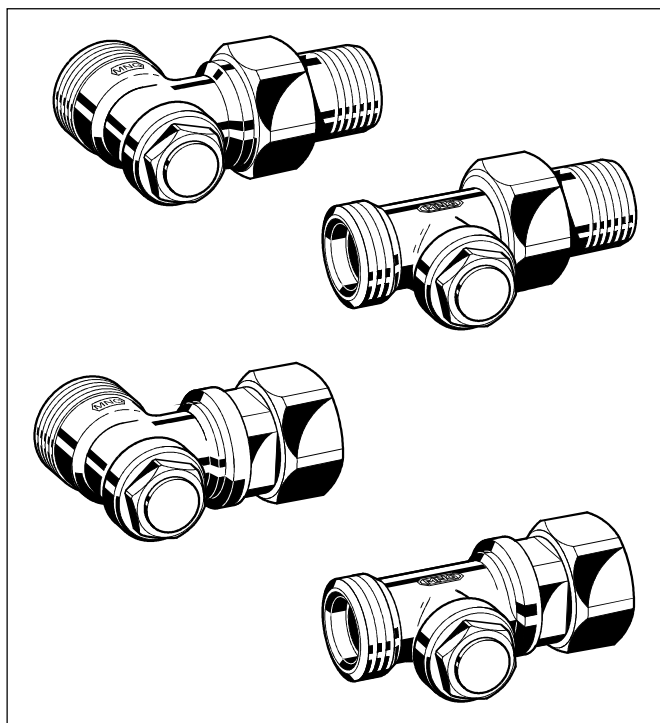

Application

The Verafix-EK-MES is a set of one control valve and one measuring valve. They are used to connect compact radiators and universal radiators to heating loops in two-pipe heating systems.

The Verafix-EK-MES offers shutoff, pre-setting, measuring, draining and filling function. With Verafix-EK-MES it is possible to measure the flow on the measuring valve and at the same time to throttle the flow on the control valve or a possible pre-settable radiator TRV insert.

It doesn't matter which valve is installed in the supply or return as both valves have optional flow direction. If the measuring valve is installed in the supply the measuring instrument has to be connected inversely, though.

One Verafix-EK-MES is required to connect a radiator to the heating loop.

Features

- Offers pre-setting, measuring, shutoff, draining and filling function
- Measuring and pre-setting at the same time
- Draining and filling by means of draining adapter with 3/4" hose connection
- Optional flow direction
- Valve housing made of corrosion-resistant red bronze
- Available with various radiator connections

Specifications

Medium	Heating water
pH-value	8...9,5
Operating temperature	max. 130°C (266°F)
Operating pressure	max. 10 bar (145 P.S.I.)
kvs-values	1,7 (pre-setting valve, angle) 1,45 (pre-setting valve, straight) 0,2/1,0 (measuring valve, angle) 0,2/0,9 (measuring valve, straight)

Design

The sets are made up of:

- Valve housing PN10, DN15, valve inlet with external threads 3/4" Eurocone for connection of copper, soft steel, plastic or composite pipe using connection fittings (see 'Accessories' on page 3)
- Valve insert
- Cap
- Union-nut, partly with tailpiece. Suitable for radiators with G 3/4" external threads or R 1/2" internal threads

Materials

- Valve housing made of nickel-plated red bronze RG5 according to DIN 1705
- Valve insert made of brass with EPDM O-rings
- Cap made of nickel-plated brass with PTFE sealing
- Union-nut and tailpiece made of brass, union-nut additionally nickel-plated

Function

The flow through the radiator is throttled by pre-setting the flow rate. Pre-setting can either be done at the control valve or at a possible pre-settable radiator TRV insert.

To pre-set the control valve proceed as follows:

- Shutoff valve with 4 mm Allan key.
- Turn limiting ring clockwise to stop with screwdriver.
- Turn limiting ring anti-clockwise number of turns as per flow diagram on page 4.
- Open valve as far as possible with 4 mm Allan key.

The valve is now pre-set. Pre-setting is retained even when valve is shutoff, e.g. to remove the radiator.

Optionally a measuring device can be connected to the measuring valve to control the flow or pre-set the control valve according to actual flow. Measuring is done when system is operating. The Verafix-MES-adapter is required to connect a measuring device to the valve – see ‘Accessories’ further below.

The radiator is shutoff from the heating loop by turning the valve inserts of both valves clockwise as far as possible. The radiator can be drained or filled over the Verafix-EK-MES by using the draining adapter (accessory).

Verafix-EK-MES are supplied set fully open.

Dimensions

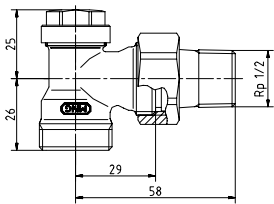

Fig. 1. Angle 3/4" to 1/2" external thread

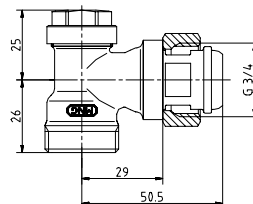
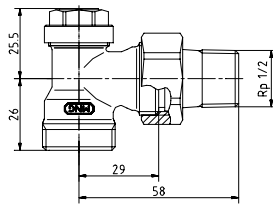

Fig. 2. Angle 3/4" external to 3/4" internal thread

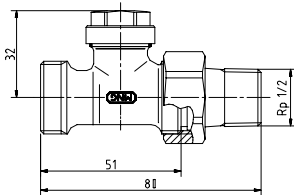
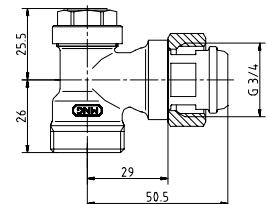

Fig. 3. Straight 3/4" to 1/2" external thread

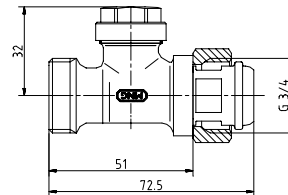
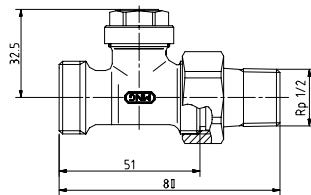
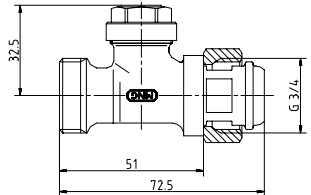

Fig. 4. Straight 3/4" external to 3/4" internal thread



NOTE: All dimensions in mm unless stated otherwise.

Ordering Information

Table 1. Ordering information and OS-Nos. (OS = Ordering System)

Type	DN	valve inlet	valve outlet	kvs-value	OS-No.
Angle	15	3/4" external	1/2" external	1,70	V2467EX020
Angle	15	3/4" external	3/4" internal	0,2/1,0	V2467DY015
Straight	15	3/4" external	1/2" external	1,45	V2467DX020
Straight	15	3/4" external	3/4" internal	0,2/0,9	V2467DY015

Accessories

Mesuring adapter

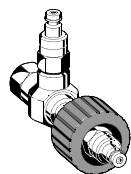

for measuring valve 0 01 01 45 010 016

Orifice type flow meter



for measuring valve 0 86 00 17 000 000

BasicMES measuring computer



for measuring valve 6 86 12 00 100 000

Draining adapter

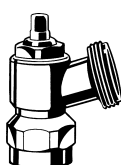





for all Verafix-EK-MES 0 08 08 02 000 000

Special Verafix-key







for all Verafix-EK-MES 0 44 20 00 110 000



External thread fittings for copper and soft steel pipe (2 pcs)

	3/4" x 10 mm	1 01 01 47 100 000
	3/4" x 12 mm	1 01 01 47 120 000
	3/4" x 14 mm	1 01 01 47 140 000
	3/4" x 15 mm	1 01 01 47 150 000
	3/4" x 16 mm	1 01 01 47 160 000
	3/4" x 18 mm	1 01 01 47 180 000

External thread fittings for plastic pipe (2 pcs)

	3/4" x 12x 2 mm	1 01 01 46 120 000
	3/4" x 14 x 2 mm	1 01 01 46 140 000
	3/4" x 16 x 2 mm	1 01 01 46 160 000
	3/4" x 17 x 2 mm	1 01 01 46 170 000
	3/4" x 18 x 2 mm	1 01 01 46 180 000

External thread fittings for composite pipe (2 pcs)

	3/4" x 14x 2 mm	1 01 01 46 240 000
	3/4" x 16 x 2 mm	1 01 01 46 260 000
	3/4" x 18 x 2 mm	1 01 01 46 280 000

Radiator tailpiece with thread up to collar

	for all Verafix-EK-MES	0 20 17 01 015 801
---	------------------------	--------------------

Extension tailpiece

	for all Verafix-EK-MES	0 20 17 03 015 000
--	------------------------	--------------------



Soldering tailpiece

	for all Verafix-EK-MES	0 20 53 01 015 000
---	------------------------	--------------------

Nickel-plated union nut

	for all Verafix-EK-MES	0 20 18 15 015 926
---	------------------------	--------------------

Nickel-plated cap

	for pre-setting valve	0 20 55 01 250 926
	for measuring valve	0 20 55 13 250 926

Sealing for cap

	for all Verafix-EK-MES	0 40 45 10 210 000
---	------------------------	--------------------

Flow Diagramm Control Valve

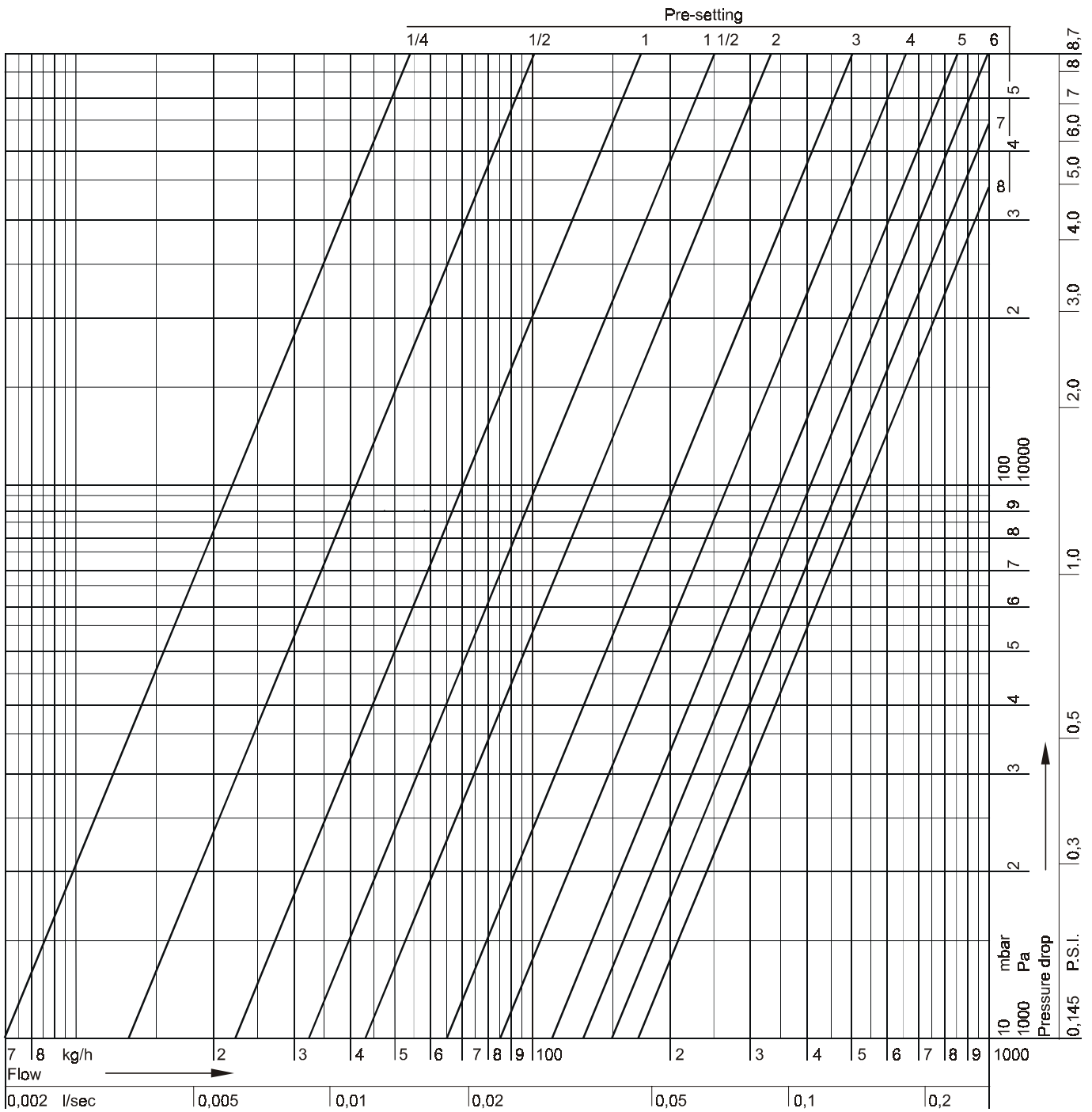

Pre-setting = Number of turns	1/4	1/2	1	1 1/2	2	3	4	5	6	7	8 = open
kv-value angle	0,07	0,13	0,22	0,32	0,43	0,65	0,85	1,1	1,3	1,5	kvs = 1,70

Flow Diagram Measuring Valve

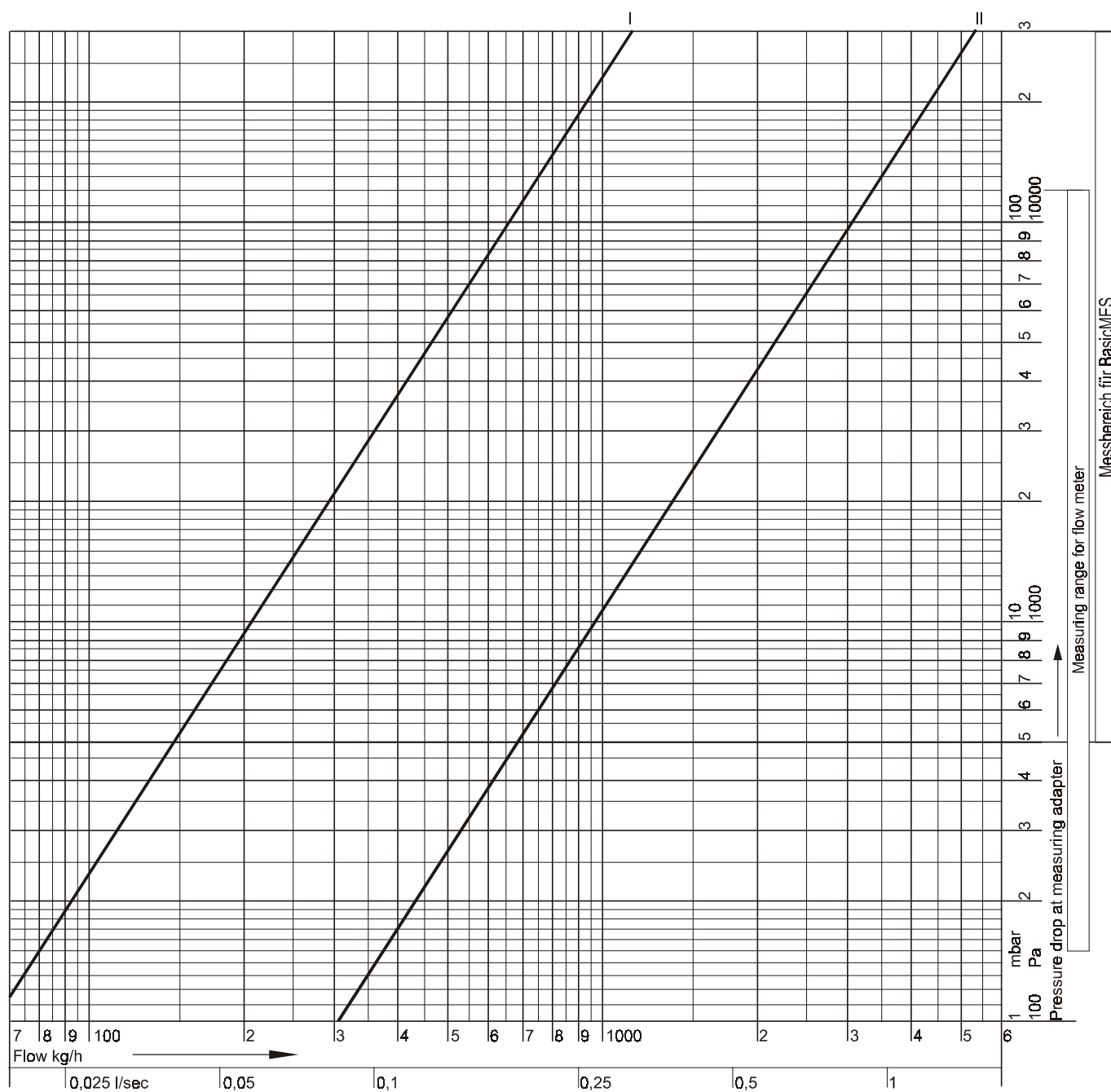

kv-values

Measuring range	I	II
Angle pattern	0,2	1,0
Straight pattern	0,2	0,9

Honeywell

Home and Building Control

Honeywell AG
Zu den Ruhrwiesen 3
D-59755 Arnsberg-Neheim

Phone: (49) 2932 9880
Fax: (49) 2932 988259
mng@honeywell.com

<http://europe.hbc.honeywell.com>