

T6101, T6102

Underfloor Heating Controllers

CONTROL OF UNDERFLOOR HEATING LOOPS

PRODUCT DATA

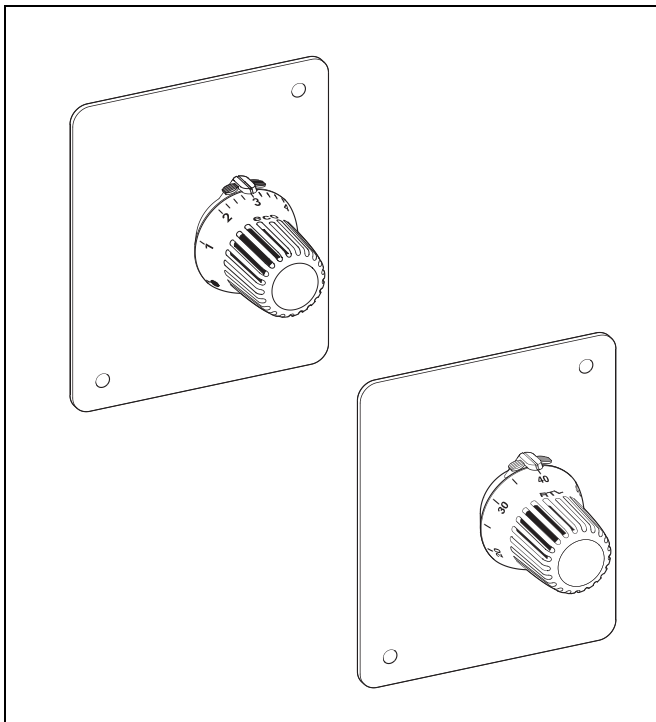

Design

The sets consist of:

- Underwall case with lid
- Protective render lid for use during building phase
- Thera-RTL or Thera-3 thermostat
- Thermostatic valve PN10, DN15, double or horizontal angle body, with external threads to ISO 228 (Eurocone). Connections for copper, plastic or composite tube - see 'Accessories'
- Air vent

Materials

- Handwheel and socket made of plastic, white to RAL9016
- Lid made of sheet steel, white to RAL9016
- Underwall box and render lid made of dark grey plastic
- Thermostatic valve made of red bronze (horizontal angle body) or brass (double angle body)
- Valve insert made of brass with EPDM O-rings and seat sealing
- Air vent made of brass

Application

The underfloor heating sets are used to control underfloor heating loops with or without additional radiator.

The RTL-Set limits the return temperature of an underfloor heating loop in combined underfloor/radiator heating systems. The thermostat is set between 20 and 50°C (68 and 122°F) depending on the desired return temperature. It is available with visible or concealed thermostat. The RTL-Set with the concealed thermostat is set only once whereas the setting of the visible thermostat can easily be changed anytime.

The Room Control-Set controls the flow of the medium through the underfloor heating loop depending on the ambient room temperature.

As the return temperature is controlled, the system designer has to make sure that the supply temperature is suitable for the floor design of the underfloor heating system. A too high supply temperature may result in damage to the floor and to the floor construction.

Features

- Easy readability of set temperature from every angle
- Equipped with concealed limiting and blocking tabs
- Valve inserts follow AT-Concept

Specifications

Medium	Heating water, quality to VDI 2035
ph-value	8 - 9.5
Setting range	RTL-Set approx. 20...50°C (68...122°F) Room Control-Set approx. 6...28°C (43...82°F)
Operating pressure	Max. 10 bar (145 psi)
Differential pressure	Max. 1 bar (14.5 psi)
k_{vs} -value	RTL-Set with visible thermostat - 1.0 with concealed thermostat - 1.7 Room Control-Set - 1.0

Function

Return temperature limiter are installed in the return of a radiator or underfloor heating loop. When the return flow temperature rises the valve closes and the flow through the heating loop is throttled. When the return flow temperature decreases the valve opens and the flow increases.

The function of the Room Control-Set is identical except for the control mode. The thermostat senses the ambient room temperature and controls the flow of the medium through the heating loop accordingly.

Please Note:

- To avoid stone deposit and corrosion the composition of the medium should conform with VDI-Guideline 2035
- Additives have to be suitable for EPDM sealings
- System has to be flushed thoroughly before initial operation with all valves fully open
- Any complaints or costs resulting from non-compliance with above rules will not be accepted by Honeywell
- Please contact us if you should have any special requirements or needs

Dimensions and Ordering Information

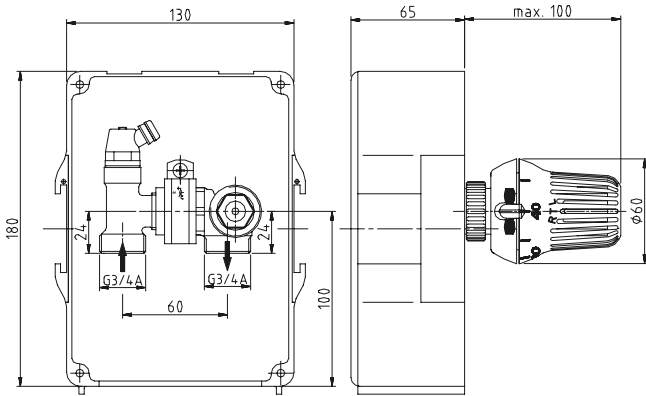

Fig. 1. RTL-Set with visible thermostat

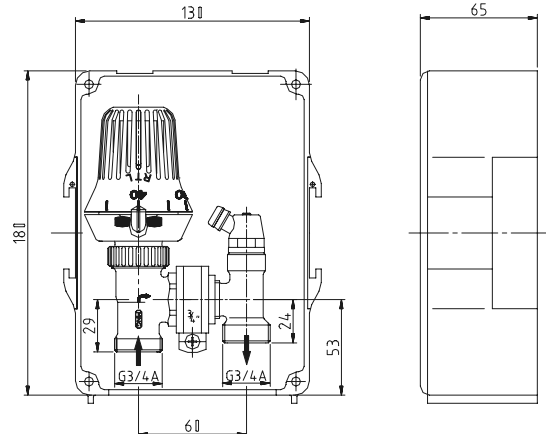

Fig. 2. RTL-Set with concealed thermostat

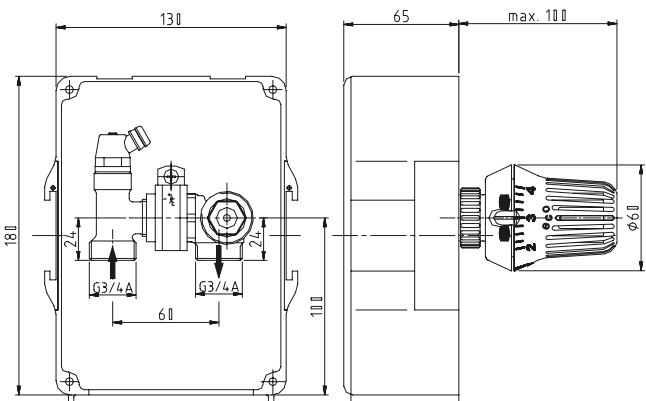

Fig. 3. Room control-set

Table 1. Available versions and OS-Nos (OS=Ordering Specification)

Type	k_{vs} (cv)-value	OS-No.
RTL-Set with visible thermostat	1.0	T6102RUB15
RTL-Set with concealed thermostat	1.7	T6102AUB15
Room Control-Set	1.0	T6101RUB15

Installation Examples

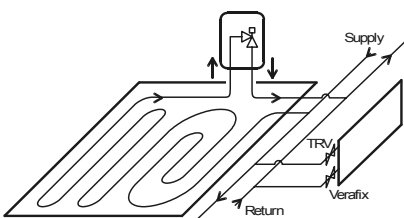

Fig. 4. RTL-Set

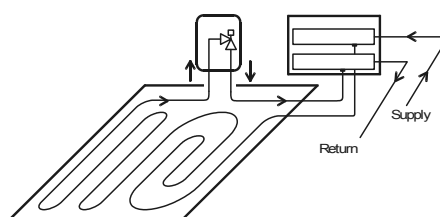

Fig. 5. Room Control-Set (return)

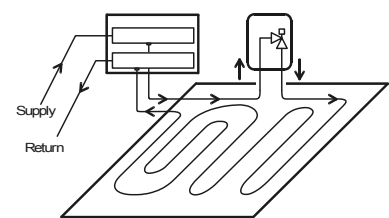











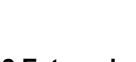

Fig. 6. Room Control-Set (supply)

Accessories



2 Connections for copper and soft steel pipe

	3/4" x 10 mm	VA7200A010
	3/4" x 12 mm	VA7200A012
	3/4" x 14 mm	VA7200A014
	3/4" x 15 mm	VA7200A015
	3/4" x 16 mm	VA7200A016
	3/4" x 18 mm	VA7200A018

2 External connections for plastic pipe

	3/4" x 12 x 2 mm	VA7210A012
	3/4" x 14 x 2 mm	VA7210A014
	3/4" x 16 x 2 mm	VA7210A016
	3/4" x 17 x 2 mm	VA7210A017
	3/4" x 18 x 2 mm	VA7210A018

2 External connections for composite pipe, alpex-therm

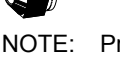
	3/4" x 14 x 2 mm	VA7220A014
	3/4" x 16 x 2 mm	VA7220A016
	3/4" x 18 x 2 mm	VA7220A018

NOTE: Processing after technical documentation of the several companies

Flow Diagram

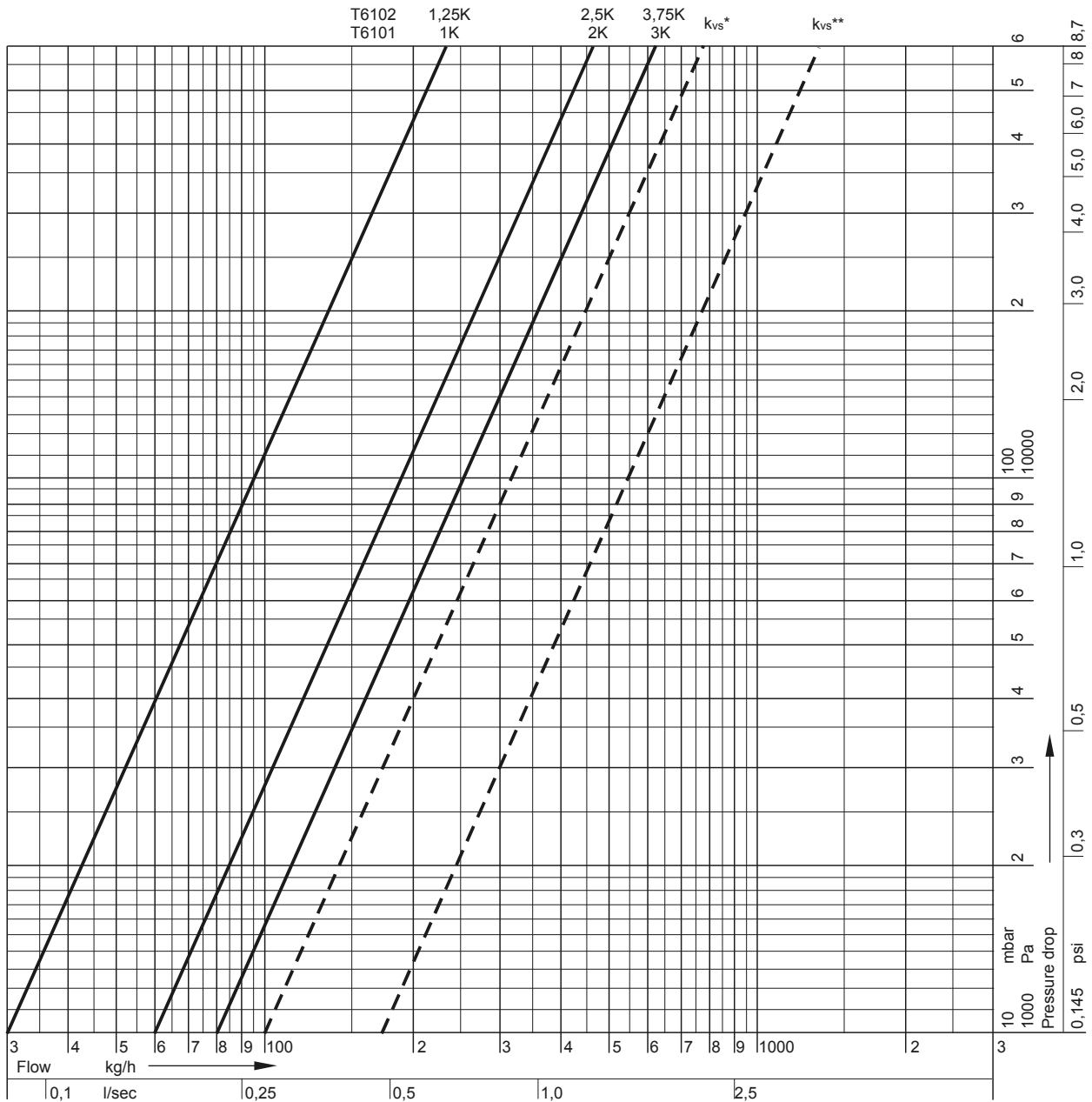

Table 2. Flow values

P-Band T6102	P-Band T6101	k _{vs} (cv)-value
1.25 K	1.0 K	0.3
2.5 K	2.0 K	0.6
3.75 K	3.0 K	0.8
open = k _{vs}		1.0*
		1.7**

NOTE: * k_{vs}-value of RTL-Set with visible thermostat
 ** k_{vs}-value of RTL-Set with concealed thermostat (T6102 only)

Automation and Control Solutions
 Honeywell GmbH
 Hardhofweg
 74821 Mosbach, Germany
 Phone: +49 (6261) 810
 Fax: +49 (6261) 81393
 www.honeywell.com

EN0H-2011GE25 R1206
 Dezember 2006
 © 2006 Honeywell International Inc.
 Subject to change • All rights reserved
 Manufactured for and on behalf of the Environmental and Combustion
 Controls Division of Honeywell Technologies Sàrl, Ecublens,
 Route du Bois 37, Switzerland or by its Authorized Representative.

Honeywell