



Thera - 20

Projecthead Series

Radiator Thermostat

APPLICATION

A Radiator Thermostat is installed onto a Thermostatic Radiator Valve Body (TRV body). The combination of both, the Thermostatic Radiator Valve (TRV), controls the room temperature by adjusting the flow of hot water through a radiator.

TRVs are installed in water-based heating systems on the supply or, less commonly on the return connection of radiators.

Radiator thermostats of this type with liquid sensor fulfill the European Standard EN 215 when used with certified Honeywell Home TRV bodies.

Honeywell Home radiator thermostats with Honeywell Home (HW) M30 x 1.5 connection are suitable for all TRV body and radiator inserts with M30 x 1.5 connection and 11.5 mm closing dimension.

Radiator Thermostats of this type with snapping (DA) type connection are suitable for TRV bodies and valve inserts with Danfoss (RA) type compatible snap connection.



FEATURES

- Conforms with M30 x 1.5 connection to European standard EN 215
- With internal liquid-filled sensing element
- Equipped with easy to use range stoppers
- Modern ergonomical design

SPECIFICATIONS

Thermostat connection:	
HW type:	M30 x 1.5
DA type:	Snap connection
Setpoint range with zero position:	0 - * - 1 - 5
Setpoint range without zero position:	* - 1 - 5
Temperature with zero position:	1 - 26 °C (34 - 79 °F)
Temperature without zero position:	6 - 28 °C (43 - 82 °F)
Closing dimension:	11.5 mm
HW type:	

Note: Zero-position is also thermostatically controlled - when temperature falls the TRV may open.

DESIGN

The radiator thermostat consists of:

- Handwheel with socket
- Honeywell Home HW M30 x 1.5 connection and 11.5 mm closing dimension or Danfoss snapping RA type connection
- Sensor with support cage
- Spindle assembly
- Connection nut

MATERIALS

- Handwheel, lid and socket made of plastic, white to RAL9016
- Socket, support cage and spindle assembly made of plastic
- Sensor filled with liquid
- Connection nut made of nickel-plated brass

FUNCTION

Radiator thermostats of this type control the TRV body. The air passing around the sensor of the radiator thermostat causes the sensor to expand when the temperature rises. The expanding sensor closes the TRV accordingly. When the room temperature changes the TRV opens or closes proportionally. Only the amount of water required to maintain the room temperature set on the radiator thermostat is allowed to flow through the valve.

DIMENSIONS AND ORDERING INFORMATION

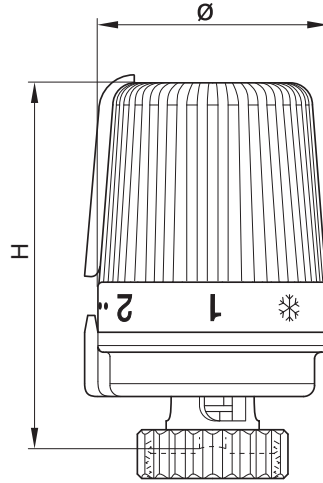

Fig. 1 Thera-20 with internal sensor

Tab. 1 Dimensions

Type	H closed	H open	Ø	L
Thera - 20	82.5	88.5	52	-
Thera - 20 DA	90.0	96.0	52	-

Note: All dimensions in mm unless stated otherwise.

Tab. 2 Available versions and OS-Nos (OS=Ordering Specification)

Type	EN 215 certification	Zero-position ('0')	Connection	OS.-No.
Liquid sensor	•		M30 x 1.5	1004712
	•	•	M30 x 1.5	1004715
			DA type	1004711
		•	DA type	1004714

SET POINT

Tab. 3 Radiator thermostats of this type with zero-position ('0')

Setpoint	0	❄	1	2	3	4	5
°C	1	6	10	15	20	23	26

Tab. 4 Radiator thermostats of this type without zero-position ('0')

Setpoint		❄	1	2	3	4	5
°C		6	12	16	20	24	28

Note: All °C and °F-values approximate. Heating can freeze when radiator thermostats with zero-position are set at position '0'. Zero-position is also thermostatically controlled - when temperature falls the TRV may open.

EN 215 INFORMATION

All radiator thermostats of this type with M30x1.5 connection in connection with certified Honeywell Home TRV bodies conform to the European Standard EN 215.

Tab. 5 Comparison of radiator thermostats of this type specs and EN 215 requirements

	Thera-2	EN 215 requirements
Min. set point temperature	6 °C (43 °F)	5 - 12 °C (41 - 54 °F)
Max. set point temperature	28 °C (82 °F)	≤ 32 °C (90 °F)
Hysteresis	0.4 K	≤ 1.0 K
Influence of differential pressure	0.22 K	≤ 1.0 K
Influence of heating medium	0.35 K	≤ 1.5 K
Response time	approx. 21 min	≤ 40 min

Note: All °C- and °F-values specified at ideal incident flow. This can differ from stated values depending on installation position and air flow.

Note: Influence of differential pressure depends on TRV body used.

INSTALLATION EXAMPLES

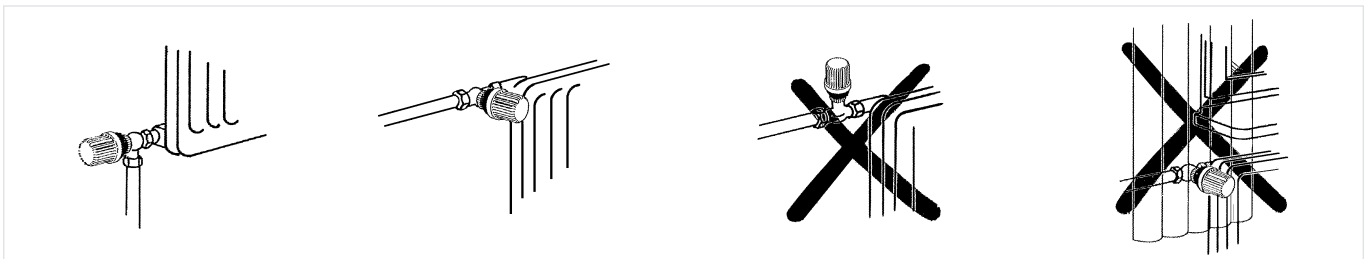
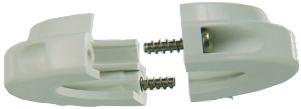





Fig. 2 Correct and false installation positions for radiator thermostats with internal sensor

Please Note:

- To avoid stone deposit and corrosion the composition of the medium should conform with VDI-Guideline 2035
- Additives have to be suitable for EPDM sealings
- System has to be flushed thoroughly before initial operation with all valves fully open
- Any complaints or costs resulting from non-compliance with above rules will not be accepted by Honeywell Home
- Please contact us if you should have any special requirements or needs

ACCESSORIES

	Description	Dimension	Part No.
	TA6900A Theft - protection ring		
	white (RAL9016)		TA6900A001
	TA1000A Decorating for connection nut		
	white (RAL9016) 10 pair, 20 pieces chrome 10 pair, 20 pieces		TA1000A001 TA1000A002
	TA1010HZ HZ - Adapter		
	HZ-Adapter from M28 x 1.5 with 9.5 mm closing dimension to M30 x 1.5 with 11.5 mm closing dimension		TA1010HZ01
	TA1010DA DA - Adapter from Danfoss		
	Snap connection RA to M30 x 1.5		TA1010DA01
	VA8210A Special tool for assembly of radiator thermostats		
			VA8210A001

For more information

homecomfort.resideo.com/europe



Ademco 1 GmbH
Hardhofweg 40
74821 MOSBACH
GERMANY
Phone: +49 6261 810
Fax: +49 6261 81309

Manufactured for and on behalf of the
Pittway Sàrl, La Pièce 4, 1180 Rolle, Switzerland
by its Authorised Representative Ademco 1 GmbH
EN0H-2025GE25 R0520

Subject to change

© 2020 Pittway Sàrl. All rights reserved.

This document contains proprietary information of Pittway Sàrl and its affiliated companies and is protected by copyright and other international laws. Reproduction or improper use without specific written authorisation of Pittway Sàrl is strictly forbidden. The Honeywell Home trademark is used under license from Honeywell International Inc.

Honeywell Home