

CBU146

Compact Booster Unit

To ensure the quality of potable water according to EN1717

Instructions

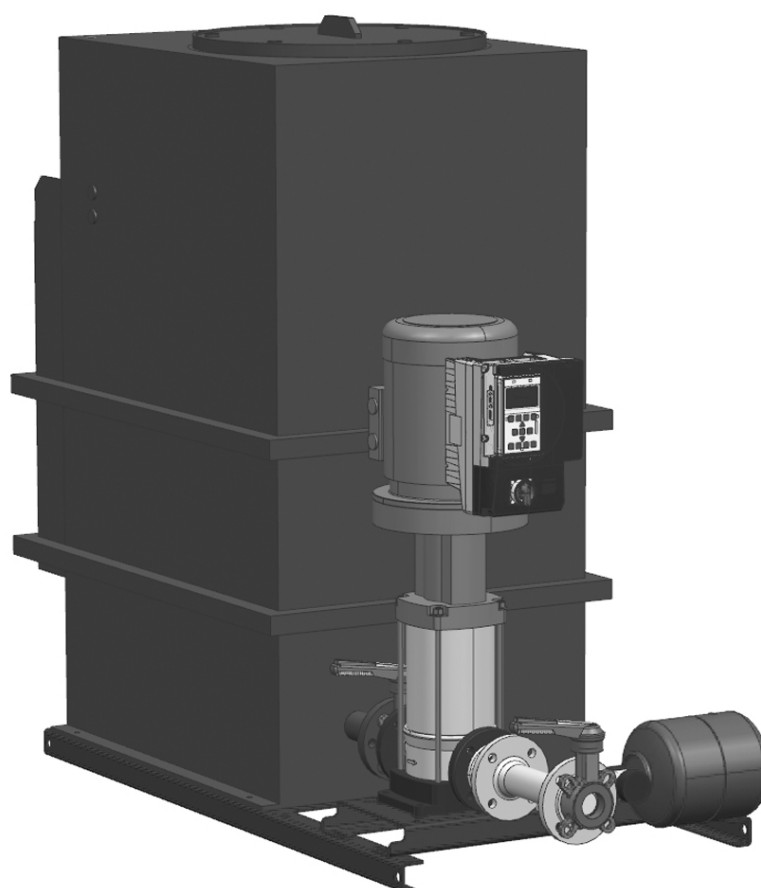





Contents

1. Safety Guidelines	3	7.1 General safety instructions	10
1.1 Safety instructions in this manual	3	7.2 Installation according to EN1717	10
1.2 Safety instructions in the system	3	7.3 Inspection before assembly	11
1.3 General safety instructions	3	7.3.1 Installation site	11
1.4 Further safety regulations	3	7.4 Installing the compact booster unit	11
1.5 Unauthorised operation types	3	7.5 Installing the pipelines	11
1.6 Software changes	3	7.5.1 Connecting the overflow	11
1.7 Residual dangers in handling the compact booster unit	3	7.5.2 Installing the compensator (optional)	11
1.7.1 Mechanical residual dangers	4	7.6 Buffer tank	11
1.7.2 Residual dangers pertaining to fluids	4	7.7 Installing valves	11
1.7.3 Residual electrical hazards	4	7.8 Electrical connection	11
1.7.4 Residual biological hazards	4	7.8.1 Safety instructions	11
1.7.5 Residual chemical hazards	4	7.8.2 Connection specifications	11
1.7.6 Consequences and dangers that result from not observing the manual	4	7.9 Standby indicator	11
1.8 Basic Safety Measures	5	8. Start-up	12
1.8.1 Keep information available	5	8.1 Safety instructions for start-up	12
1.8.2 For environmental protection	5	8.2 Start-up requirements	12
1.8.3 Modifications to the compact booster unit	5	8.3 Initial operation	12
1.9 Duty of due care of the operator	5	8.3.1 Change switch-on pressure	12
1.10 Safety instructions for the operator/operating personnel	5	8.4 Switching the system on	12
1.11 Safety instructions for maintenance, inspections and assembly work	5	8.5 Start-up checklist	13
1.12 Requirements for operating personnel	5	9. Operation	13
1.12.1 Operating personnel	5	9.1 Function of operating panel	13
1.13 Personal safety equipment	5	10. Maintenance	13
2. General information	6	10.1 Safety instructions for maintenance	13
2.1 Conformity with the following norms	6	10.2 Inspection	13
2.2 Warranty and liability	6	10.2.1 Buffer tank	13
2.3 Storage and perfect condition	6	10.2.2 Monitoring Operation	13
2.4 Illustrations	6	10.2.3 Checklist for Inspection	14
2.5 Symbols	6	10.3 Maintenance	14
2.6 Other applicable documents	6	10.3.1 Setting the precharge pressure for the membrane pressure vessel	14
2.7 Glossary	6	10.3.2 Cleaning the dirt trap	14
3. Description	7	10.3.3 Checklist for maintenance work	14
3.1 Overview	7	11. Troubleshooting	14
3.1.1 Installation type	7	12. Shut-down, restart	14
3.2 Intended use	7	12.1 Shutting down the compact booster unit	14
3.3 Non-intended use	7	12.2 Restarting the compact booster unit	14
3.4 Version	8	13. Storage	14
3.5 Options	8	13.1 Short-term storage	14
4. Function	8	13.2 Storage/Preservation	14
4.1 Inlet side	8	13.3 Storage conditions	14
4.2 Outlet side	8	14. Disassembly, disposal	15
4.3 Indicator LED	8	14.1 Safety instructions for disassembly	15
4.4 Mode of operation	8	15. Spare parts	15
5. Technical data	9	16. Start-up protocol	16
5.1 Noise expectancy values	9	17. Declaration of no objection	17
5.2 Authorised environmental conditions	9	18. Proof of Maintenance	18
6. Shipping	10		
6.1 Check condition upon delivery	10		
6.2 Transportation	10		
7. Assembly	10		

1. Safety Guidelines

1.1 Safety instructions in this manual

 Danger
Places with this sign signify that death, severe bodily injury or significant property damage will occur if the appropriate precautionary measures are not followed!
 Warning
Places with this sign signify that death, severe bodily injury or significant property damage may occur if the appropriate precautionary measures are not followed!
 Caution
Places with this sign signify that small bodily injury or slight property damage may occur if the appropriate precautionary measures are not followed!

 Places with this sign provide technical information and tips on usage that damage to the machine must be avoided. This symbol is not a safety indication.

 Places with this sign provide information about possible hazards to the environment

 Please notice that a safety symbol never can replace the text of the safety instruction itself - the text of the safety instruction must be read entirely!

1.2 Safety instructions in the system

 Danger of burning on hot surfaces of pump housing
--

1.3 General safety instructions

This manual contains basic instructions which are to be observed in transport, assembly, start-up, operation, maintenance, shut-down, storage and waste disposal.

The following safety instructions have to be observed while operating the compact booster unit:

- When using the compact booster unit, the data, operation and usage conditions specifically authorised in the technical data sheet and the operating manual have to be observed.
- Never exceed the permissible limits pertaining to pressure, temperature, etc. as stated in the documentation.
- Observe all safety instructions as well as the operating instructions of the manual.
- Instructions that are directly attached to the system have to be observed and must be kept completely legible. This applies for example to:
 - Safety instructions
 - Arrow for rotation direction
 - Connection labels
 - Type label
- Before assembly and start-up, the manual has to be read by the operator as well as by the responsible technical/operating personnel and has to be stored at the site of the compact booster unit at all times.
- Installation and maintenance work may only be performed by authorised specialist personnel with the appropriate tools.
- The technical condition of the compact booster unit has to be checked regularly (at least once a year) by the operating company.
- The local safety and accident regulations have to be observed when operating the compact booster unit.
- The general technical rules must be observed when planning the usage and operating the device.
- Modification of the compact booster unit is not permitted and leads to the loss of warranty.
- After an interruption of the electrical or fluid supply, a defined or controlled re-run of the process must be ensured.
- The operator is responsible for complying with local regulations that are not covered by the manual.

1.4 Further safety regulations

Besides the safety instructions presented in this manual and its intended use, the following safety regulations are valid:

- Accident prevention regulations, safety and operating regulations
- Safety regulations for handling hazardous substances
- Applicable standards and laws

1.5 Unauthorised operation types

The limits that are stated in the documentation have to always be complied with. The delivered system is only guaranteed to operate reliably when it is used as intended.

1.6 Software changes

The software was especially developed for this product and has been thoroughly tested. Changing or adding software or software parts is not permitted. Excluded from this are the software updates provided by Honeywell.

1.7 Residual dangers in handling the compact booster unit

Danger and adverse effects may result from use of the compact booster unit

- for the body and life of the operator or third person
- for the compact booster unit itself
- to other property.

The basis for safe and error-free operation of the compact booster unit is knowledge of the instructions for safety and operation in this manual.

1.7.1 Mechanical residual dangers

During normal operation, no danger is threatened from mechanical components.

1.7.2 Residual dangers pertaining to fluids

During normal operation, no danger is threatened by hydraulic components.

Hazards might result solely under the following conditions.

Danger area	Type of hazard	Reduction of hazard
Pipelines	Injury through high pressure	Clear pipelines of pressure and medium prior to assembly, maintenance, shut-down!

1.7.3 Residual electrical hazards

During normal operation, no danger results from the electrical equipment of the compact booster unit.

Hazards might result solely under the following conditions.

Danger area	Type of hazard	Reduction of hazard
Injury from cables	Danger to life ! Electric shock of 230/400V from electric voltage	Connect up protective earth system!
		Always switch off power supply and secure against switching on again during maintenance and servicing work!
		Comply with the valid accident prevention and safety regulations for electrical devices!
Electrostatically endangered components / subassemblies	The device contains electronic componental elements that react sensitively to electrostatic discharge (ESD). Contact with electrostatically charged persons or objects endangers these componental elements. Worst case scenario: they will be immediately destroyed or fail after start-up.	Comply with requirements according to EN 100 015 - 1, in order to minimise or avoid damage through shock-type electrostatic discharge!
		Do not touch electronic componental elements when the power supply is on!

1.7.4 Residual biological hazards

During normal operation, no biological danger results from the compact booster unit.

Hazards might result solely under the following conditions.

Danger area	Type of hazard	Reduction of hazard
Buffer tank	Danger of microbial contamination	Clean the buffer tank regularly!

1.7.5 Residual chemical hazards

During normal operation, no chemical danger results from the compact booster unit.

Hazards might result solely under the following conditions.

Danger area	Type of hazard	Reduction of hazard
Use of detergents	Danger through contact with or breathing in dangerous fluids, gases, fumes, vapours or dust	Wear personal safety equipment!
		Pay attention to the safety specifications sheet of detergent manufacturers!

1.7.6 Consequences and dangers that result from not observing the manual

- Not observing this manual will lead to loss of the warranty and make damage claims invalid.
- Failure to observe the manual can lead, for example, to the following dangers:
 - Hazard to persons caused by electrical, thermal, mechanical, and chemical influences
 - Loss of important product functions
 - Failure to perform required maintenance and service measures
 - Environmental hazard caused by leakage of hazardous substances

1.8 Basic Safety Measures

1.8.1 Keep information available

This manual has to be stored. It has to be ensured that all persons who operate the compact booster unit have access to the manual at all times.

1.8.2 For environmental protection



When operating or servicing the compact booster unit, the regulations concerning waste avoidance and the proper recycling or disposal of waste must be observed.

Particular attention must be paid that materials and agents dangerous to the groundwater such as fats, oils, coolants, solvent-based liquid detergents, etc. do not pollute the ground or access the sewage system. These materials must be caught in suitable tanks, stored, transported and properly disposed of.

1.8.3 Modifications to the compact booster unit

When using externally procured parts, there is no guarantee that these are designed and constructed to tolerate demands made upon them or whether they comply with safety regulations.

For safety reasons, no unauthorised modifications may be made to the compact booster unit.

Parts and special equipment not delivered by Honeywell are also not authorised by Honeywell for use.

1.9 Duty of due care of the operator

This compact booster unit was designed and constructed according to a risk assessment and after careful selection of the harmonised standards that apply, as well as according to further technical specifications. It thus complies with best practice and guarantees the highest safety standard.

This level of safety can only be attained during operational practice if all required safety measures have been taken. It is the duty of care of the operator of the compact booster unit to plan these measures and enforce their implementation.

In particular, the operator must ensure that

- the compact booster unit is only operated as intended
- the compact booster unit is only operated in perfect working condition.
- the manual has to be kept legible at all times and stored on-site with the compact booster unit.
- the compact booster unit is assembled, commissioned, operated, maintained, and shut down solely by sufficiently qualified and authorised personnel.
- this personnel is regularly instructed on all relevant questions of work safety and environmental protection, and has also read and understood the manual and particularly the safety instructions it contains.
- none of the safety and warning signs attached to the compact booster unit are removed and all remain legible.
- a hazard assessment (according to the Safety at Work Act § 5) is conducted to detect further hazards that may arise from the particular working conditions on-site where the compact booster unit is operated.
- all further information and safety instructions which arise from the hazard assessment process shall be summarised in operating instructions (according to the work equipment regulation § 6).
- the drain output lines are sufficiently dimensioned

1.10 Safety instructions for the operator/operating personnel

- Eliminate hazards caused by electrical energy (for details refer to the country specific regulations and/or local power supply companies).

1.11 Safety instructions for maintenance, inspections and assembly work

- Alterations or modifications of the system are only permitted with the consent of the manufacturer.
- Use only original parts or parts authorised by the manufacturer.
- Use of parts other than those authorised may lead to loss of liability for any damage they may cause.
- Perform service on the system only when the machine is off.
- The pump housing has to be at ambient temperature.
- The pump housing has to be depressurised and empty.
- The procedures described in the manual for shutting down the system have to be observed under all circumstances.
- Reinstall safety equipment and protective devices and activate them again immediately after work on the system has been completed. Before starting up again, observe the start-up checklist.
- Keep unauthorised persons (e.g. children) away from the system.

1.12 Requirements for operating personnel

1.12.1 Operating personnel

This compact booster system may only be assembled, started, maintained, and shut down by persons who have been trained, instructed and authorised to do so.

In some cases, training can be arranged by the manufacturer if asked by the operator.

Training or personnel to operate system may only be conducted under the supervision of specialised technicians.

The relevant authorisations of the personnel are to be specified by the operating company in the form of an operating instruction.

Over and above this, special qualifications are required for the following tasks:

- Only electricians may perform work on electrical equipment.
- Assembly, maintenance, servicing and repair work may only be performed by qualified, specialist personnel

The basic regulations on work safety and accident prevention are to be observed.

1.12.1.1 Qualified personnel

Qualified personnel are persons who on account of their training, experience and instruction also their knowledge of the relevant norms, regulations, accident prevention regulations and operating conditions, including those persons responsible for the safety of the system, have been authorised to perform the relevant and required tasks, meanwhile being able to recognise and avoid dangers. This includes required knowledge of First Aid measures and the local ambulance services and facilities.

1.13 Personal safety equipment

No personal safety equipment is required to operate the compact booster unit.

2. General information

The manual is a part of the series and the versions as mentioned on the title page. The manual describes the safe and proper use in all modes of operation.

The type label indicates the series and size, the most important operating data and the order number. The factory number/serial number describes the identifies the system uniquely and serves this purpose for all further business transactions.

In order to maintain the warranty, in the event of damage immediately contact the nearest Honeywell service centre.

2.1 Conformity with the following norms

Pump unit: Machinery Directive 2006/42/EG

Pump unit: EMC Directive 2004/108/EG

Frequency inverter: EMC Directive 2004/108/EG

Frequency inverter: Low voltage directive 2006/95/EG

2.2 Warranty and liability

As a matter of principle, the general sales and delivery terms of the Honeywell Company apply. Warranty and liability claims for injury to persons and damage to property are ruled out if they arise from one or more of the following causes.

- Non-intended use of the compact booster unit
- Improper assembly, start-up, operation and maintenance of the compact booster unit
- Failure to comply with the instructions in the manual concerning transport, storage, assembly, start-up, operation, maintenance, and service of the compact booster unit
- Unauthorised constructional modifications of the compact booster unit
- Improperly performed repairs
- Catastrophes through effect of a foreign object or force majeure

2.3 Storage and perfect condition

This instruction manual is a part of the compact booster unit and has to be complete and accessible at all times. Any instruction or page that is missing has to be replaced immediately.

2.4 Illustrations

The illustrations used are examples of one possible version of the compact booster unit and might differ in individual cases from the actual compact booster unit version.

2.5 Symbols

1. Start of a task description
2. Next work step
 - Result of an action
- List of several options
- 📄 Reference to other documents

Pictogram	Danger classification
☐	Danger source
⚡	Consequence of non-compliance
○	Avoidance

2.6 Other applicable documents

- 📄 Product data sheet CBU146
- 📄 Operating instructions of the operating company
- 📄 Data sheets
- 📄 Documentation for the circuit diagram
- 📄 Wiring scheme
- 📄 Instructions for the frequency inverter
- 📄 Instructions for the pump
- 📄 Instructions for the pressure sensor
- 📄 Instructions for the throttle valve
- 📄 Instructions for the membrane pressure vessel
- 📄 Instructions for the check valves
- 📄 Instructions for magnetic valves
- 📄 Declaration of Conformity

2.7 Glossary

EN 1717

European standard that specifies technical regulations for potable water installations.

Noise expectancy values

The expected noise emission, stated here as sound pressure level (SPL) in dB(A).

Membrane pressure vessel

The membrane pressure vessel is for compensating pressure drops in the pipeline network behind the compact booster unit, that can occur because of loss of minimal quantities.

That minimises the frequency of operation of the compact booster.

Certificate of no objection

A certificate of no objection is a declaration that the system has been cleaned properly so that parts that have been in contact with medium are not dangerous for health and environment.

3. Description

Speed controlled compact booster unit with a vertical high-pressure pump as a safety device to separate potable water from category 5 fluids according to EN 1717.

Fully automatic, fully wired Compact Booster Unit with modular design comprising a single pump system and a buffer tank for the hygienic separation of potable water and category 5 fluids according to DIN EN 1717, on a common base frame.

The modular design makes it possible to disconnect modules for installation in buildings with limited space.

The system is switched on and off regulated by pressure, the flow rate is controlled via frequency inverter..

Separation of systems as a means to protect potable water from being contaminated by fluids of the category 5 according to EN 1717

Pump medium	Non-potable water Without aggressive, abrasive and solid components
Flow rate	see chapter 5. Technical data
Pumping head	Adjustable within the range of pump characteristics, preset to 60m see chapter 5. Technical data
Medium temperature	up to 30 °C
Ambient temperature	up to 40 °C
Nominal pressure	PN 16
Inlet pressure	1.5 - 8 bar (depending upon the model)
Supply voltage	3/PE, AC 400 V, 50 Hz

3.1 Overview

The system comprises one multi-speed high-pressure rotary pump with inlet and outlet shut-off valves. They can be locked with padlocks against unauthorised closing. They make it possible to disassemble the pump or the check valves without having to empty the pipeline system. The check valve on the pumping side prevents liquid from backing up on the pump and flowing backwards through it, and it relieves the floating ring seal.

The fully automatic Compact Booster Unit with compact design comprising:

- vertical high-pressure pump
- frequency converter adapted on the motor to ensure a constant supply pressure to the points of consumption

construction and operation is according to DIN 1988, EN 1717 and EN 13077.

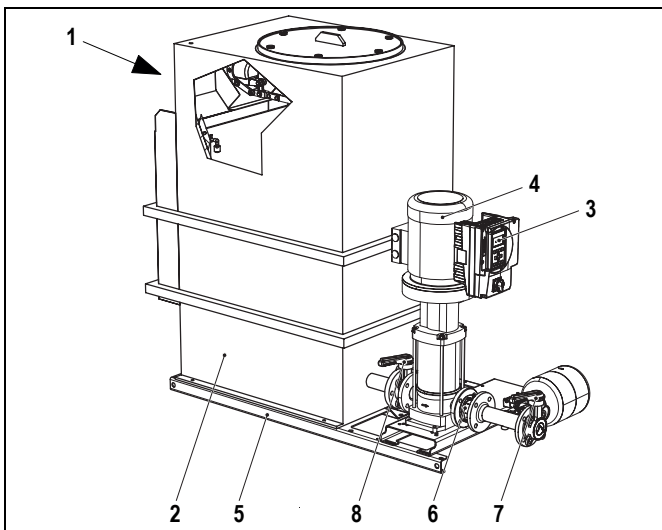

Figure 1: CBU146 Construction

1 Inlet	5 Base frame
2 Buffer tank	6 Check valve
3 Display	7 Inlet shut-off valve
4 Pump	8 Outlet shut-off valve

3.1.1 Installation type

- Fixed installation

3.2 Intended use

The compact booster unit may only be operated in such areas as described in the other applicable documents.

Non-intended operation of the compact booster unit can result in danger to persons, systems, the surroundings and the environment.

- Operate the compact booster unit only if it is in perfect working condition.
- Do not operate the compact booster unit if it is only partially assembled.
- The compact booster unit may only be used to pump the medium as described in the documentation of the respective version.
- Never operate the compact booster unit without pump medium.
- Observe the values for minimum pumping rates (avoiding damage because of overheating, storage damage, ...).
- Observe the values for maximum pumping rates (to avoid damage due to overheating, floating ring seal damage, cavitation damage, storage damage, ...).
- Do not throttle the input of the compact booster unit (to avoid cavitation damage).
- Other modes of operations, if not mentioned in the documentation, have to be coordinated with the manufacturer.

3.3 Non-intended use

The compact booster unit is not designed for operation outside. Temperature, light and moisture can lead to malfunctions and damaging devices.

- Do not operate the compact booster unit outside.
- Operate the compact booster unit only as intended.
- Do not fill aggressive or flammable medium into the medium lines of the system.
- No mechanical stress on housings (e.g. by depositing objects or as a step).
- Do not perform any external modifications on the device housing. Do not paint housing parts and screws!
- Do not disassemble the compact booster unit more than is necessary for purposes of installation and maintenance.

3.4 Version

Speed-controlled compact booster unit with:

- 1 normal sucking, vertical high-pressure rotary pump with all components in contact with the medium made of stainless steel
- High efficiency motor with frequency inverter, energy efficiency class IE4 according to IEC-CD 60034 - 30 ED. 2
- Check valve
- Shut-off valve on the inlet and outlet sides
- Diaphragm expansion vessel on the outlet side as vessel
- Pressure sensor on the pressure side
- Vibration damper between pump and base frame
- Pressure gauge display
- Shut-off valve, lockable
- Piping made of stainless steel
- The system is connected to the installation pipeline with G1 1/4", G2" or G2 1/2" (depending on version)
- Base frame made of coated steel

Self-cooled frequency converter adapted on the motor

- ▣ Refer to instructions of frequency inverter

Buffer tank made of polyethylene with:

- Non-circular, free overflow according to EN 13077, Type AB
- Drainage connection with integrated siphon trap:
DN100 for CBU146-32A-060 and CBU146-40A-060
DN150 for CBU146-50A-060, CBU146-65A-060,
CBU146-65B-060 and CBU146-80B-060
- Tank volume according to DIN 1988-500 or individual approved
- Potable water backfeed via float valve, suitable for potable water

Switch cabinet consists of:

- Power supply connection via 3/N/PE, AC 400V, 50Hz
- Lockable emergency stop main switch (repair switch)
- LED, green for normal function, yellow for warning, red for alarm and description text in the display
- Motor protection device (Included in the frequency inverter)
- Terminal strip/clamps with labels for all connections
- Plug connectors to connect easily with the electrical equipment fitted to the supply container.

Messages sent via potential-free contact for

- Alarms and warnings
- Pump run indicator

3.5 Options

CBU146-32A-060	refer to technical data for type selection
CBU146-40A-060	refer to technical data for type selection
CBU146-50A-060	refer to technical data for type selection
CBU146-65A-060	refer to technical data for type selection
CBU146-65B-060	refer to technical data for type selection
CBU146-80B-060	refer to technical data for type selection

4. Function

4.1 Inlet side

On the inlet side there is a buffer tank. It has a floating valve on its inlet to refill water. The water level is measured with two float switches. They send messages in the case of water shortage and overflow. The overflow has an integrated siphon trap and can be directly connected to the drain.

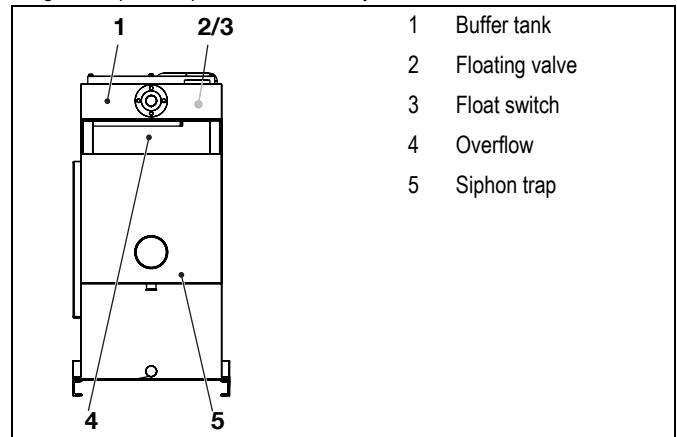

Figure 2: CBU146 Inlet side

4.2 Outlet side

On the outlet side there is a diaphragm expansion vessel as well as a pressure sensor and a pressure gauge.

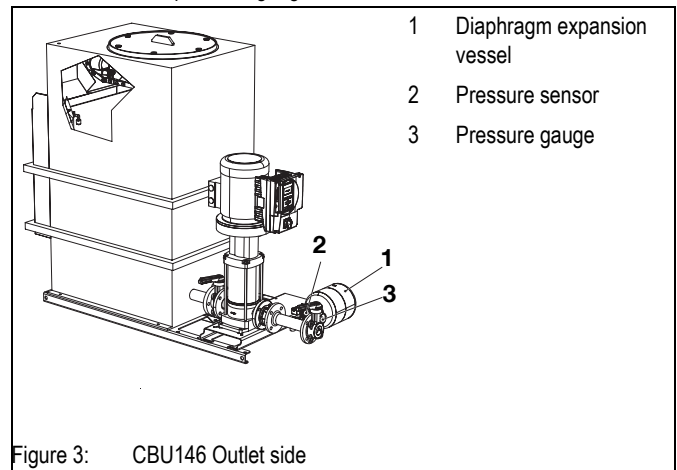

Figure 3: CBU146 Outlet side

4.3 Indicator LED

LED, green for normal function, yellow for warning, red for alarm and description text in the display

4.4 Mode of operation

The pump is switched on based on pressure, and off based on quantity, by a fully-automatic control unit. If a pre-set pressure setting is exceeded, the pump switches on and the frequency converter regulates the compact buster unit to the set value, so that a constant pressure is always available. The speed decreases as consumption reduces and the compact booster unit switches off after a set minimum run time (0 to 600 seconds, default set to 60 seconds).

6. Shipping

6.1 Check condition upon delivery

1. Check the contents of each package for damage upon delivery.
2. In the case of transport damage estimate the extent, document the damage and notify Honeywell immediately in writing.

6.2 Transportation

 Danger
<ul style="list-style-type: none"> <input type="checkbox"/> Overturning the system <ul style="list-style-type: none"> ↳ Danger of being crushed by system! <ul style="list-style-type: none"> ○ Never get the system tangled in electrical lines. ○ Observe the local safety regulations. ○ Observe the weight and mass centre. ○ Only use appropriate and authorised means of transportation, for example fork lift or hand lift.

 Warning
<ul style="list-style-type: none"> <input type="checkbox"/> Installation on non-level and non-structural installation sites <ul style="list-style-type: none"> ↳ Personal and property damage! <ul style="list-style-type: none"> ○ Ensure sufficient compressive strength according to class C12/15 for concrete in the exposition class X0 according to EN 206-1. ○ The installation site has to be solid, level and horizontal. ○ Observe the weight information.

 The compact booster unit is attached to wooden rails and wrapped in foil for transport and temporary storage. All connection interfaces have protective lids.

The system can be divided into three parts, to facilitate transportation if necessary. For this purpose, the plug connections of the system to the switch cabinet have to be disconnected, the hydraulic connections of the pump suction side of the flange have to be disconnected, and the buffer tank has to be disconnected from the base frame.

1. Selecting the adequate transportation device for the weight class.
2. Transporting the system to the installation site.
 - divide into three parts if necessary.
3. Detach the wooden rails of the system and dispose of them.
4. Lift the system with a suitable lifting device and place it carefully at the installation site.
5. Reassemble the divided system and restore the mechanical and electrical connections.

7. Assembly

7.1 General safety instructions

 Danger
<ul style="list-style-type: none"> <input type="checkbox"/> Danger for persons, near-by systems and the the environment that arises from the non-intended use of the compact booster unit. <ul style="list-style-type: none"> ○ Operate the compact booster unit only as intended. <input type="checkbox"/> Injury through high pressure in the system. <ul style="list-style-type: none"> ○ Pipelines have to be depressurised and emptied before assembling the compact booster unit. <input type="checkbox"/> Danger through uncontrolled start-up of the system <ul style="list-style-type: none"> ○ Secure the system against unintentional operation during installation. ○ After an interruption of the electrical or fluid supply, a defined or controlled re-run of the process must be ensured.

 Warning
<ul style="list-style-type: none"> <input type="checkbox"/> The compact booster unit is not designed for operation outside. <ul style="list-style-type: none"> ↳ Temperature, light and moisture influences can lead to malfunctions and damage to devices. <ul style="list-style-type: none"> ○ Do not use the compact booster unit outside. <input type="checkbox"/> Danger through improper installation <ul style="list-style-type: none"> ↳ Personal and property damage! <ul style="list-style-type: none"> ○ Performance of tasks only by qualified personnel (see section 1.12). <input type="checkbox"/> Installation on non-level and non-structural installation sites <ul style="list-style-type: none"> ↳ Personal and property damage! <ul style="list-style-type: none"> ○ Ensure sufficient compressive strength according to class C12/15 for concrete in the exposition class X0 according to EN 206-1. ○ The installation site has to be solid, level and horizontal. ○ Observe the weight information.

 Caution
<ul style="list-style-type: none"> <input type="checkbox"/> Damaged or improperly installed compact booster unit. <ul style="list-style-type: none"> ↳ Malfunctions <ul style="list-style-type: none"> ○ Do not damage the compact booster unit and only install it if it is clean and fully functional. ○ Install the compact booster unit according to the described instructions. ○ Install free of voltage and of bending moments. <input type="checkbox"/> Individual housing parts are to be removed for the installation process, which means that the IP protection of the device is no longer complete. <ul style="list-style-type: none"> ○ No water is to enter into the device interior during assembly.

7.2 Installation according to EN1717

Accomodate the compact booster unit in a technical centre or in a frost-free, well ventilated, lockable room that is not used for anything else. Hazardous gases should never enter the installation room. A sufficiently dimensioned dewatering connection (drain connection or similar) is required (observe EN 12056).

Usable volume tank	Dewatering capacity
540 l	25 m ³ /h
350 l	25 m ³ /h

Table 6: Usable volume/dewatering capacity

 Do not operate the compact booster unit near living rooms and bedrooms.

 If compensators are used to damper vibrations, their durability has to be ascertained.

Compensators have to be able to be easily replaced.

7.3 Inspection before assembly

7.3.1 Installation site

- i** Sufficient noise insulation for the building is ensured due the compact booster unit's safety store.
The system has to be installed above the flood level. Provide a suitable lifting device for underfloor installation.

- Inspect the building architecture.
 - The architecture of the building has to be prepared according to the data sheets.
 - The concrete foundation is true to size and completely solid.

7.4 Installing the compact booster unit

- Warning**
- The system is top heavy
 - ↳ Danger of injury!
 - Secure the system so that it cannot tip over before it has been permanently anchored.
 - Anchor the system securely to the foundation.

- i** Make allowance for space for operating and maintenance tasks.

- Remove the packaging before installing the system.
- Connect the system refilling and discharge pressure lines with the distribution lines on the refilling and discharge side (DIN 1988).
- Mark the installation holes on the floor as described in the data sheet.
- Drill holes (maximum Ø12 mm).
- Insert suitable, proper sized dowels.
- Position the system for installation.
- Anchor the system solidly to the foundation with adequate bolts.

- i** To avoid the transfer of pipeline forces and structure-borne sound to the compact booster unit, it is recommended to install compensators with a tie bar.

7.5 Installing the pipelines

- i** Always install pipelines so that they are free of tension.
The use of compensators with tie bars (refer to the accessories section) is recommended.

7.5.1 Connecting the overflow

- Caution**
- Overflow not connected
 - ↳ Danger of flooding the installation room!
 - Lead the overflow line to a drain with adequate dewatering capacity (connection DN150).

- Lead the pipeline to the drain.

7.5.2 Installing the compensator (optional)

- i** If compensators are used to damper vibrations, their durability has to be ascertained.
Compensators have to be able to be easily replaced.

- Danger**
- Sparks and radiant heat
 - ↳ Fire hazard!
 - Take appropriate measures to protect the compensator during welding work in the vicinity.

- Caution**
- Leaky compensator
 - ↳ Danger of flooding the installation room!
 - Check regularly for rips and blisters, exposed material or other defects.

- Install the compensator in the pipeline without tension.
 - Never correct misalignment and offset pipes with the compensator.
- Fasten bolts equally cross-wise.
 - The bolt ends should not protrude from the flange.

- i** Do not paint the compensator and always protect it against oil.
The compensator has to be accessible on the compact booster unit at any time for inspection purposes and for this reason should not be included in the pipe insulation.
The compensator is subject to wear.

7.6 Buffer tank

- Caution**
- Dirt in the system
 - ↳ Damage to the pumps!
 - Rinse the tank before filling it.
 - Rinse the tank and the integrated odour trap regularly.

- i** The DIN 1988 allows for the installation of a pressure-free buffer tank together with the compact booster unit. The same regulations apply for their installation as for the compact booster unit.
The buffer tank made of polyethylene fulfils the requirements of EN 1717 and EN 13077, with free drain type AB.

7.7 Installing valves

All additional valves in the terminal lines such as sliders, water meters and check valves have to be dimensioned according to the values stipulated by the competent water distribution company.

7.8 Electrical connection

7.8.1 Safety instructions

- Danger**
- Danger of injury from electric voltage.
 - ↳ High shock currents and burns from direct and indirect contact with live parts.
 - Turn off the power supply before assembling the compact booster unit and secure it from being turned on.
 - Non- or erroneously-connected cables
 - ↳ Malfunctions, which endanger the safety of operating personnel.
 - Work on electrical equipment may only be performed by specialist electric technicians.
 - Observe regulation IEC 30364 (DIN VDE 0100) and for explosion protection IEC 60079 (DIN VDE 0165).
 - Faulty mains connection
 - ↳ Damage to the electricity network, short circuit!
 - Observe the conditions for technical connections of the local power supply companies.
 - Wrongly wired connections
 - ↳ Destruction of electrical / electronic components.
 - Work on electrical equipment may only be performed by specialist electric technicians.
 - Improperly connected wiring and lines (e.g. too small bend radius)
 - ↳ Smouldering and fires from cables.
 - Work on electrical equipment may only be performed by specialist electric technicians.
 - Live cable ends and components
 - Make sure the protective earth system is connected throughout.

7.8.2 Connection specifications

Power supply connection 3/N/PE, AC 400V, 50Hz

- i** The circuit diagrams of the respective systems are kept in the switching device and should always remain there. The documentation included with the switch cabinet contains a list of electronic parts. Please always specify the circuit diagram number when ordering spare electronic parts.

- i** The diameter of the electrical supply line has to be determined according to the total connection value.

7.9 Standby indicator

The system standby mode has to be registered by the operator or their contractors at the responsible authority (most commonly WVU or factory inspectorate). Before starting the system, the author has to certify that the prerequisites for connection are fulfilled.

Before the system is connected to the mains power supply, the operator has to read the relevant VDE regulations.

The electrical supply lines must only be installed by companies that are authorised to do such work.

8. Start-up

 Performance of tasks only by qualified personnel (see section 1.12).

8.1 Safety instructions for start-up

<p> Warning</p> <ul style="list-style-type: none"> <input type="checkbox"/> Danger from improper operation. <ul style="list-style-type: none"> ↳ Malfunctions <ul style="list-style-type: none"> ○ Before starting, the manual has to be read by the operator as well as by the responsible technical/operating personnel and has to be stored at the site of the compact booster unit at all times. ○ Adhere to local safety and accident regulations when starting the compact booster unit. <input type="checkbox"/> Damaged or improperly installed compact booster unit. <ul style="list-style-type: none"> ↳ Malfunctions <ul style="list-style-type: none"> ○ Check the compact booster unit for obvious signs of damage; eliminate any defects immediately or alert the supervising personnel. The compact booster unit may only be operated in perfect working order.

Inform yourself sufficiently about

- the equipment of the compact booster unit
- the functionality of the compact booster unit
- the close surroundings of the compact booster unit
- the measures to be taken in an emergency

8.2 Start-up requirements

<p> Caution</p> <ul style="list-style-type: none"> <input type="checkbox"/> Dry running pump <ul style="list-style-type: none"> ↳ Damage to the pump/system! <ul style="list-style-type: none"> ○ Ensure that there is no water shortage.
--

 The responsible authorities have to be informed before start-up and before testing.

Before start-up of the compact booster unit, the following points have to be ensured:

- The compact booster unit has to be connected to all protective equipment according to the regulations.
- The relevant VDE and country-specific regulations have to be adhered to and fulfilled.
- The buffer tank has to be full of water.
- The refilling has to function properly.
- Flange connections have to be checked if they are fastened tightly.
- Pipe fittings between pump and pipeline have to be tightened.
- In and output openings for air-cooling of the motor are free.
- The precharge pressure of the membrane pressure vessel is checked.
- All shut-off valves in the system are open.

8.3 Initial operation

The initial start-up should be performed by Honeywell technical staff.

<p> Caution</p> <ul style="list-style-type: none"> <input type="checkbox"/> The pipeline must be free of residue <ul style="list-style-type: none"> ↳ Danger of damaging the pump/compact booster unit! <ul style="list-style-type: none"> ○ Before start-up (and testing) make sure that pipelines and compact booster unit are free of residues.

<p> Caution</p> <ul style="list-style-type: none"> <input type="checkbox"/> No pressure on the output side <ul style="list-style-type: none"> ↳ Pump starts when main switch is turned on! <ul style="list-style-type: none"> ○ During start-up and also during automatic mode, the pump starts as soon as the main switch is turned on, because the system receives a start command from the pressure sensor due to the lack of pressure on the output side. This is not even prevented if the motor protection switch is also activated.

 In case of water shortage the system does not start.

 The start-up, or testing mode, of the compact booster unit may only be initiated if all VDE regulations have been fulfilled.

 Floating ring seals may briefly show signs of leakage during start-up, but no longer after a short period of operation.

1. Connect electrical circuit on-site.
2. Connect water supply for refilling on-site.
3. Open or loosen the ventilation screws on the pump (refer to operating/assembly instructions).
4. Slowly open the shut-off valves on the input side and fill the system until water runs out of every ventilation borehole.
5. Close the ventilation screws, tighten pump ventilation lightly.
6. Set main switch to I.
7. Check direction of pump rotation.
 - The direction of rotation has to be the same as the direction shown by the arrow on the motor. If it is rotating in the wrong direction, two phases of the inlet have to be exchanged.
8. Slowly open the shut-off valve of the output and use the pressure gauge to check if the system starts if the switch-on pressure is reached (refer to Chapter 5.).
 - If the switch-on pressure is set to the wrong value, it has to be changed as described in chapter 8.3.1.
9. Slowly close the shut-off valve of the output and use the pressure gauge to check if the system shuts off when the switch-off pressure is reached (refer to Chapter 5.).
 - If the switch-on pressure is set to the wrong value, it has to be changed as described in chapter 8.3.1.
10. Let the pump run again with the output shut-off valve open, loosen the ventilation screw and let the rest of the air out.
11. Close the ventilation screw tightly.
12. Check if the pump runs smoothly.

8.3.1 Change switch-on pressure

1. Click on the settings key indicated by a spanner symbol
2. Move up and down using the arrow keys to setting value 1-2-3-3
3. Press OK key
4. Move up and down using the arrow keys to desired setting value for the discharge pressure in bars.
5. Press OK key confirm the set value
6. For any further information please Refer to instructions of frequency inverter

8.4 Switching the system on

1. Secure the shut-off valves of the in and output against being closed.
2. Operate the main switch to supply the system with voltage.
 - The green LED indicates that the unit is ready to use.

8.5 Start-up checklist

Work steps	finished	
1	Read instructions.	
2	Check the voltage supply and compare with the values on the type label.	
3	Check the grounding system (by measurement).	
4	Check the mechanical connection to the water supply system. Tighten the flanges and the screws.	
5	Fill and ventilate the compact booster unit from the input side.	
6	Check the refilling.	
7	Check the switching device to see if all electrical lines are still securely plugged into the clamps.	
8	Check the rotation direction.	
9	Check the switch-on and switch-off pressure, correct if necessary.	
11	Venting the pump a second time, after it has been running for a few minutes (5 to 10).	
12	Set the switch to automatic.	
13	Check the precharge pressure (refer to Chapter 10.3.1).	
14	Secure the shut-off valves of the in and output lines against being closed	
15	Circumstances regarding the system that are not the same as stated in our documentation or ordering data, have to be noted in the start-up protocol.	
16	Fill out the start-up protocol with the operator and show the operator how the machine functions.	

9. Operation

9.1 Function of operating panel

- Refer to instructions of frequency inverter

10. Maintenance

- Maintenance should be performed by Honeywell technical staff.
 - If necessary contact the service department at Honeywell.
 Performance of tasks only by qualified personnel (see section 1.12).

10.1 Safety instructions for maintenance

 Danger
<input type="checkbox"/> Unintentionally switching on the compact booster unit ↳ Danger to life! <input type="checkbox"/> The compact booster unit has to be voltage free for all repairs and maintenance work. Turning off the system with the motor protection switch does not securely shut off the motor inlet lines. <input type="checkbox"/> Only perform maintenance work on the compact booster unit if you are sure that the compact booster unit is free of power. <input type="checkbox"/> Secure the compact booster unit against being switched on unintentionally.

 Danger
<input type="checkbox"/> Danger of injury from electric voltage. ↳ High shock currents and burns from direct and indirect contact with live parts. <input type="checkbox"/> Turn off the power supply before maintaining the compact booster unit and secure it from being turned on.

 Warning
<input type="checkbox"/> Components and lines under pressure ↳ Personal and property damage! <input type="checkbox"/> Before work is done on pressure-retaining components, the pump has to be depressurised! <input type="checkbox"/> Disconnect the pump from the power supply!

 Warning
<input type="checkbox"/> Inappropriate lifting/moving of heavy modules or components ↳ Personal and property damage! <input type="checkbox"/> When moving heavy modules or components, use suitable transport devices, lifting devices and lifting accessories.

 Warning
<input type="checkbox"/> Unqualified persons working on the compact booster unit ↳ Danger of injury! <input type="checkbox"/> Only let specially qualified personnel perform repair and maintenance work.

 Caution
<input type="checkbox"/> Inappropriately maintained compact booster unit ↳ The proper function of the compact booster unit can no longer be ensured! <input type="checkbox"/> Maintain the compact booster unit regularly. <input type="checkbox"/> Set up a maintenance schedule for the compact booster unit that focuses especially on the pump lubrication, shaft seal and clutch.

- Always observe the safety regulations and instructions.

- Observe the instructions for working on the pumps.

- In case of damage, please contact our service department.
 By setting up a maintenance schedule, the required maintenance to avoid expensive repairs and achieve fault-free and reliable functioning of the compact booster unit is held to a minimum.

10.2 Inspection

- To ensure that the compact booster unit can be operated reliably, the required inspections have to be conducted on time.

10.2.1 Buffer tank

 Caution
<input type="checkbox"/> Dirt in the system ↳ Damage to the pumps! <input type="checkbox"/> Rinse the tank before filling it. <input type="checkbox"/> Rinse the tank and the integrated odour trap regularly.

- Rinse the inlet to the buffer tank if necessary.
- Rinse the tank and the integrated odour trap regularly.
- Check if the overflow is sealed and clean.

10.2.2 Monitoring Operation

 Danger
<input type="checkbox"/> Filling wrong gas in expansion vessel ↳ Danger of poisoning! <input type="checkbox"/> Only fill the pressure pad with nitrogen.

 Caution
<input type="checkbox"/> Dry running causes increased wear ↳ Damage to the pump unit! <input type="checkbox"/> Never operate the pump unit when it is empty. <input type="checkbox"/> Never close the shut-off valve in the suction line and/or supply line during operation.

 Caution
<input type="checkbox"/> Exceeding the permissible temperature for the pumped medium ↳ Damage to the pumps! <input type="checkbox"/> Operation is not permitted with closed shut-off valves over longer periods of time (overheating of pump medium). <input type="checkbox"/> Observe the temperature values as stated in the data sheet and under technical data.

During operation observe and check the following points:

- Check the functional operation.
- Check switch-on/off pressure when operating the pump and compare to the values on the type label.
- Compare the precharge pressure of the membrane pressure vessel to the recommended values (refer to Chapter 10.3.1).



- Close the shut-off valves under the tank and empty the tank with the drain valve.
 - Unscrew the protective cap of the valve on the membrane pressure vessel and check the precharge pressure with a tire gauge.
 - Refill nitrogen if necessary.
4. Check the running noise of the roller bearings.
 - Vibrations, noise, and increase in power consumption for consistent operating conditions are a sign of wear.
 5. Check the function of any additional connections.

10.2.3 Checklist for Inspection

If you conduct inspections on your own, they have to be done at least once a year according to the following criteria:

Work steps	finished
1 Read instructions.	
2 The pump and drive motor should run smoothly, the floating ring seals should not leak.	
3 Check the elastic transmission elements.	
4 Check if the shut-off, drain and check valves function properly and don't leak.	
5 Clean the dirt trap in the pressure reducing valve (if applicable).	
6 Check the compensators for wear (if applicable).	
7 Check the precharge pressure and, if necessary, check if the membrane pressure vessel leaks (refer to Chapter 10.3.1).	
9 Check the switch-on/off points of the system.	
11 Check if the entire system is functioning properly and compare values to those on the type label.	
12 Check the water supply, precharge pressure, water shortage monitoring, and pressure reducing valve.	
13 Check the buffer tank and floating switch (refer to Chapter 10.2.1).	

10.3 Maintenance

-  Maintenance should be performed by Honeywell technical staff.
-  Alterations or modifications of the system are only permitted with the consent of the manufacturer.
Use only original parts or parts authorised by the manufacturer.
Use of parts other than those authorised may lead to loss of liability for any damage they may cause.
Reinstall safety equipment and protective devices and activate them again immediately after work on the system has been completed.
Before starting up again, observe the start-up checklist.

10.3.1 Setting the precharge pressure for the membrane pressure vessel

-  Observe the instructions for the membrane pressure vessel.

 **Danger**

- Filling wrong gas in expansion vessel
- ↳ Danger of poisoning!
- Only fill the pressure pad with nitrogen.

 **Caution**

- Precharge pressure too high
- ↳ Danger of damaging the tank!
- Observe the values as stated by the manufacturer of the tank (refer to type label or the tank manual).

The precharge pressure for the pressure vessel should be set to a value that is lower than the programmed switch-on pressure.

This setting can be made with a valve under the cover hood on the top of the tank.

Example: Precharge pressure 10% below the switch-on pressure

Precharge pressure of the membrane pressure vessel $p = 0.9 \times p_E$

p_E = switch-on pressure of the compact booster unit

Recommendation

These are average values. Experiments conducted on tanks have shown that the best storage volumes were achieved for pressures >3bar with a factor of 0.9 and pressures of <3bar with a factor of 0.8.

Example:

$p_E = 5 \text{ bar}$: Precharge pressure $5 \times 0.9 = 4.5 \text{ bar}$

$p_E = 2 \text{ bar}$: Precharge pressure $2 \times 0.8 = 1.6 \text{ bar}$

10.3.2 Cleaning the dirt trap

1. Remove the lid
2. Take out the sieve
 - blow out if necessary
3. Insert sieve
4. Replace lid
 - use new seal if necessary

10.3.3 Checklist for maintenance work

Work steps	Interval
Setting the precharge pressure for the membrane pressure vessel	yearly
Cleaning the dirt trap	yearly

11. Troubleshooting

-  During the warranty period consult the manufacturer before performing maintenance work on the system (only work that is required for start-up and maintenance).
Our customer service department is at your service. Failure to comply will lead to loss of any liability claims.

12. Shut-down, restart

12.1 Shutting down the compact booster unit

1. Set main switch to 0.
2. Secure the system against unintentional operation

-  Empty the compact booster unit if it is shut down for a longer period of time.

12.2 Restarting the compact booster unit

Please note the procedures in chapter 8.

13. Storage

13.1 Short-term storage

Short-term storage is possible without further preparation under the specified environmental conditions.

13.2 Storage/Preservation

 **Caution**

- Damage during storage caused by frost, humidity, dirt, UV radiation or pests
- ↳ Corrosion/Contamination of the system!
- Protect the system against frost, do not store outside.

 **Caution**

- Damp, dirty or damaged openings and junctions
- ↳ Danger of leaks and damaging the system!
- Uncover openings in the system only during installation.

13.3 Storage conditions

Storage location	closed room, dry and dust-free
Ambient temperature	5°C to 40°C (incl. power pack)
Relative air humidity	max. 60% r.h. at 40 °C ambient temperature

14. Disassembly, disposal

14.1 Safety instructions for disassembly

⚠ Danger

- Unintentionally switching on the compact booster unit
 - ↳ Danger to life!
 - The compact booster unit has to be voltage free during disassembly. Turning off the system with the motor protection switch does not securely shut off the motor inlet lines.
 - Only perform maintenance work on the compact booster unit if you are sure that the compact booster unit is free of power.
 - Secure the compact booster unit against being switched on unintentionally.

⚠ Danger

- Danger of injury from electric voltage.
 - ↳ High shock currents and burns from direct and indirect contact with live parts.
 - Turn off the power supply before disassembling the compact booster unit and secure it from being turned on.

⚠ Warning

- Components and lines under pressure
 - ↳ Personal and property damage!
 - Before work is done on pressure-retaining components, the pump has to be depressurised!
 - Disconnect the pump from the power supply!

⚠ Warning

- Inappropriate lifting/moving of heavy modules or components
 - ↳ Personal and property damage!
 - When moving heavy modules or components, use suitable transport devices, lifting devices and lifting accessories.

⚠ Warning

- Danger through improper disassembly
 - Performance of tasks only by qualified personnel (see section 1.12).



It is imperative to observe the laws and regulations on waste disposal of materials that are detrimental to the environment. Such materials include old oils, coolants, paint, plastics and chemicals. If in doubt, consult the manufacturer.

1. Disassembly of the system.
 - Collect grease and lubricants during disassembly.
2. Separate the pump materials for example according to:
 - Metal
 - Plastic
 - Electronic junk
 - Grease and lubricants
3. Dispose according to local regulations or have them disposed of according to regulations.

15. Spare parts

	Ordering text	Nominal size CBU	OS.-No.
1	Pump Movitec V 0609 B	DN32	0904149
	Pump Movitec V 1008 B	DN40	0904150
	Pump Movitec VF1506 B	DN50	0904151
	Pump Movitec VF 2504 B	DN65A	0904152
	Pump Movitec VF 2505 B	DN65B	0904153
	Pump Movitec VF 4004-2 B	DN80	0904154
2	Pressure sensor	all	0904155
3	Pressure gauge	all	0904156
4	Float switch	all	0904157
5	Check valve 1 1/4"	DN32 and DN40	0904158
	Check valve	DN50	0904159
	Check valve	DN65	0904160
	Check valve	DN80	0904161
6	Shut-off valve 1 1/4"	DN32 and DN40	0904162
	Shut-off valve 1 1/2"	DN32 and DN40	0904163
	Shut-off valve	DN50	0904164
	Shut-off valve	DN65	0904165
	Shut-off valve	DN80	0904166
7	Frequency inverter - Pump drive 2.2 kW	DN32	0904167
	Frequency inverter - Pump drive 3 kW	DN40	0904168
	Frequency inverter - Pump drive 5.5 kW	DN50	0904169
	Frequency inverter - Pump drive 7.5 kW	DN65A	0904170
	Frequency inverter - Pump drive 11 kW	DN65B	0904171
	Frequency inverter - Pump drive 15 kW	DN80	0904172

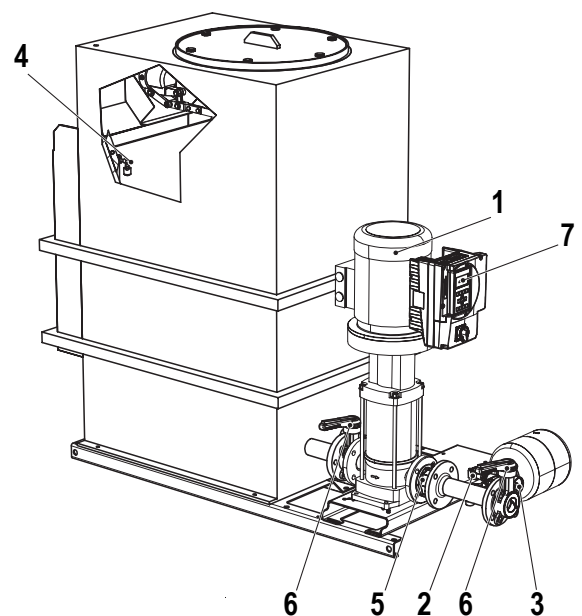

16. Start-up protocol

The following so-called Honeywell Compact Booster Unit was commissioned today by the signatories, authorised Honeywell customer service staff, and this protocol was written.

1 Compact booster unit

Series
 Size
 Serial number
 Order number

2 Customer/Operating site

Customer	Operating site
Name
Address
.....

3 operating data refer to circuit diagram for additional data

Switch-on pressure	pE bar
Monitoring the precharge pressure Setting value for the precharge pressure switch	pbefore - x
Switch-off pressure	pA bar
Precharge pressure	pbefore bar
Precharge pressure tank	pbefore bar

4 Important notes

According to the DVGW Process Sheet W 314, the company operating the system is obligated to inform the competent water distribution company of the commissioning of the system.
 If the system is additionally operated with group III/IV pressure vessels according to the regulation for pressure vessels, then the TÜV has to be informed also.

The operating company or their customer herewith certifies to be fully trained in operation and maintenance of the compact booster unit. The circuit diagrams and instructions were also delivered.

Defects determined during start-up	Scheduled elimination
Defect 1
.....
.....
.....

Name of Honeywell customer	Name of supplier and contractor
City	Date

Automation and Control Solutions

Honeywell GmbH

Hardhofweg

74821 MOSBACH

GERMANY

Phone: (49) 6261 810

Fax: (49) 6261 81309

<http://ecc.emea.honeywell.com>

Manufactured for and on behalf of the
Environmental and Combustion Controls Division of
Honeywell Technologies Sàrl, Z.A. La Pièce 16,
1180 Rolle, Switzerland by its Authorised Representative
Honeywell GmbH

MU1H-1376GE23 R1215

Subject to change without notice

© 2015 Honeywell GmbH

Honeywell